



BARRET®

ATTREZZATURE PER L'ALLENAMENTO DEI CAMPIONI
TRAINING TOOLS FOR CHAMPIONS



catalogo
2018-2019
brochure

INDICE ALFABETICO

Archi di precisione	pag. 49
Arredi spogliatoio ed infermeria	pag. 155-160
Arti Marziali, Boxe	pag. 201-203;207
Atletica	pag. 213-216
Attrezzi speciali, Scalette e Bande elastiche.....	pag. 72-85
Badminton.....	pag. 194
Bandierine e accessori per arbitro.....	pag. 112-115
Barriera filtrante, Barriera con finestre	pag. 26
Basket.....	pag. 164-171
Beach Soccer.....	pag. 162
Beach Volley	pag. 180-181
Borse	pag. 126-127
Vernice Segnacampo, Carrelli Traccialinee	pag. 149-151
Casacche, Pantaloncini, Calze, Giacche pioggia, Tubolare Barret, Numeri Termosaldabili	pag. 95-98
Ceste Portapalloni	pag. 128
Cross Training, Reti con bersagli	pag. 63;141
Delimitatori e Birilli	pag. 30-34
Deviatori di traiettoria, Ball Playning	pag. 60-62
Fitness Equipment.....	pag. 87-94
Forche	pag. 50-51
Ghiaccio, Tape, Creme, Oli.....	pag. 108-109
Ginnastica	pag. 208-212
Hockey, Baseball	pag. 199-200
Impianti Multifunzione	pag. 179
Kit Calcio Tennis	pag. 45-48
Kit tecnico Scuola Calcio	pag. 86
Lavagne Tattiche	pag. 104-106
Materassi, Protezioni Murarie	pag. 204-206
Materassini, Borracce	pag. 107;110
Minivolley.....	pag. 178
Muri e Telai con rete	pag. 52-59
Ostacoli ad altezza fissa e regolabile	pag. 35-44
Paletti Slalom.....	pag. 27-29
Pallamano	pag. 184
Palle Mediche, Ritmiche e Psicomotorie	pag. 123-125
Palloni in pelle ed in gomma	pag. 119-122
Panchine Allenatori	pag. 142-148
Parastinchi, Fasce Capitano, Guanti Portiere	pag. 102-103
Pilates, Didattica Scolastica, Pattini e Skateboard	pag. 217-220
Piscina, Pallanuoto.....	pag. 196-198
Pompe, Compressore, Cronometri e Rotelle Metriche.....	pag. 111;118
Porte regolamentari, ridotte, miniporte, porte bifrontali	pag. 129-137
Protezioni personali	pag. 182-183
Reti di Protezione	pag. 140
Reti per calci di precisione	pag. 141
Reti regolamentari e ridotte	pag. 138-139
Rugby.....	pag. 195
Sagome e Barriere.....	pag. 14-25
Sedute per gradinate e Tribune modulari per interno ed esterno	pag. 152-154
Segnalatori manuali ed elettronici per cambio giocatori	pag. 116-117
Strutture instabili e Tavolette Propriocettive, Plinti	pag. 64-70
Tabelloni elettronici segnapunti	pag. 185-187
Tacchetti ed accessori per scarpe, Lavascarpe	pag. 99-101
Tavoli calcetto	pag. 163
Tennis Tavolo	pag. 191-193
Tennis, Beach Tennis	pag. 188-190
Trampolini, Cerchi, Corde, Bastoni	pag. 71;75
Tunnel uscita spogliatoi	pag. 161
Volley.....	pag. 172-177



Centro Sportivo Milanello - Allenamento 06/02/2018 - Training session 06/02/2018



TECHNICAL SUPPLIER



Centro Sportivo Milanello - Allenamento 06/02/2018 - Training session 06/02/2018



Centro Sportivo Milanello - Allenamento 06/02/2018 - Training session 06/02/2018



TECHNICAL SUPPLIER



Centro Sportivo Milanello - Allenamento 06/02/2018 - Training session 06/02/2018



Centro Sportivo Milanello - Allenamento 12/12/2017 - Training session 12/12/2017



TECHNICAL SUPPLIER



Centro Sportivo Milanello - Allenamento 12/12/2017 - Training session 12/12/2017



Centro Sportivo Milanello - Allenamento 16/01/2018 - Training session 16/01/2018



TECHNICAL SUPPLIER



Centro Sportivo Milanello - Allenamento 16/01/2018 - Training session 16/01/2018



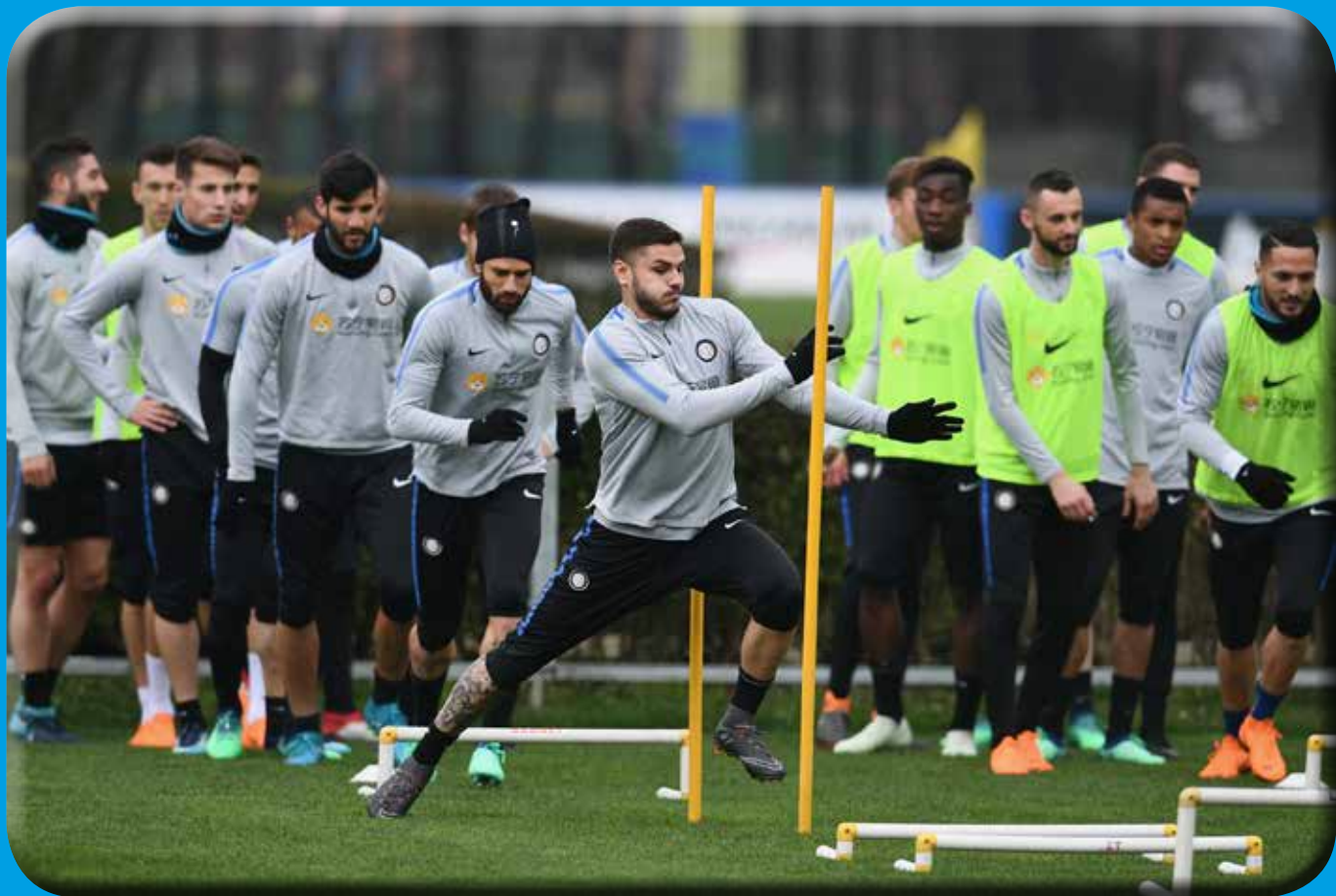







Barret Srl

Dal 1989 Barret Srl produce attrezzature tecniche per lo sport.

In particolare, l'Azienda si è affermata nel corso degli anni per la ideazione e realizzazione di strumenti di allenamento ormai divenuti indispensabili per la preparazione fisica, tecnica e tattica dei giocatori di Calcio, così come per la preparazione degli atleti di molti altri sport, sia di squadra che individuali.

Barret offre la più ampia varietà di attrezzature quali ad esempio sagome, ostacoli, delimitatori, birilli, paletti per slalom, archi di precisione, kit per Calcio-Tennis, forche, bande elastiche, slitte, plinti, tavolette propriocettive, telai con rete, muri in vetroresina, miniporte, porte bifrontali, ridotte e regolamentari.

La qualità che distingue i prodotti offerti e le numerose innovazioni proposte con continuità nel corso degli anni hanno permesso all'Azienda di affermarsi non solo sul mercato italiano, ma anche su quello internazionale.

Barret ha sviluppato nel tempo una preziosa collaborazione con Milan ed Inter, fondamentale per permettere un interscambio di idee ed informazioni con i preparatori atletici della prima squadra e del settore giovanile, finalizzato al continuo miglioramento della funzionalità delle attrezzature tecniche per l'allenamento.

I prodotti Barret, infatti, vengono utilizzati quotidianamente sui campi di allenamento di Milanello e di Appiano Gentile per coadiuvare la preparazione fisica e tecnica di alcuni tra i migliori giocatori di Calcio del mondo.

Sarebbe impresa ardua ricordare tutti i Club nazionali ed internazionali e le Nazionali che hanno scelto più volte di acquistare le nostre attrezzature attraverso la rete distributiva italiana ed estera.

Cogliamo l'occasione per ringraziare i preparatori atletici ed i responsabili acquisti di Milan, Inter, Juventus, Roma, Lazio, Napoli, Sampdoria, Fiorentina, Palermo, Torino, Empoli, Cagliari, Bologna, Sassuolo, Spal, Barcellona, Real Madrid, Bayern Monaco, Arsenal, Chelsea, Manchester City, Zenit e delle Nazionali di Calcio di Italia, Germania, Inghilterra, Francia, Spagna e Russia

Company Profile

Founded in 1989, Barret Srl gained a foothold in the international football training equipment market by creating innovative tools which have become more and more essential during training sessions of pro athletes worldwide

Barret manufactures products such as mannequins, hurdles, markers, cones, slalom poles, shooting arcs, soccer-tennis kits, heading trellises, all kinds of fiberglass and net rebounders, sledges, vaulting boxes, equilibrium boards, any size goals and mini goals.

The quality and variety of products introduced over the years make Barret the go to company when training camp is about to start.

Barret has a long history of working together with AC Milan and FC Internazionale Milano, two of the most prestigious Clubs in football history : all the inputs and feedbacks received by their coaches always pushes Barret to shape and improve new products

As a matter of fact Barret tools are used everyday at Appiano Gentile and Milanello Training Centers in order to constantly enhance AC Milan and FC Internazionale players' athletic and technical performances.

It would be nearly impossible to name all professional Football Clubs and National Teams that have chosen to purchase Barret products through our distribution network.

However we would like to take this opportunity to thank Clubs such as Milan, Inter, Juventus, Roma, Lazio, Napoli, Sampdoria, Fiorentina, Palermo, Torino, Empoli, Cagliari, Bologna, Sassuolo, Spal, Barcellona, Real Madrid, Bayern Monaco, Arsenal, Chelsea, Manchester City, Zenit and the Italian, English, German, Spanish, French and Russian National Teams.

BARRET®

Le materie prime (i vari preparati plastici ed i profilati in polipropilene copolimero ed in PVC nei vari diametri, spessori e colori) utilizzate da BARRET per lo stampaggio e l'assemblaggio degli articoli in materiale plastico sono certificate dai nostri fornitori nel rispetto delle normative vigenti che impediscono l'utilizzo di sostanze ritenute tossiche per la salute dell'uomo e dell'ambiente.

Barret manufactures plastic products in PVC and polypropylene such as dummies, cones, markers, hurdles, slalom poles etc. using only certified non toxic raw materials not dangerous for human beings and the environment.

NUOVI PRODOTTI - NEW PRODUCTS

Pag. 74

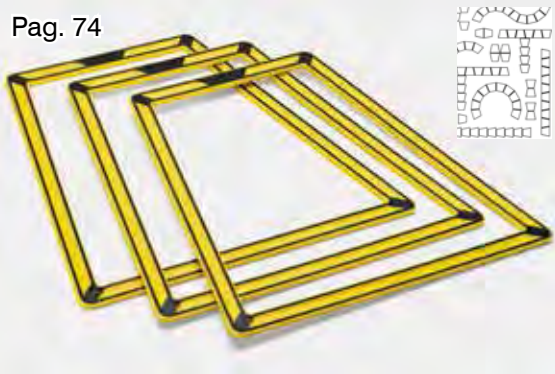

Art. SK.ATP

Agility Trainer Pro - set 10 TRAPEZI componibili per allenamento agilità e coordinazione multidirezionale
Agility Trainer Pro



Pag. 73

Art. SK.ELD

Elevation Ladder - scaletta trasformabile in serie di 6 ostacoli h. cm. 10
Switch between a flat ladder and a series of 6 hurdles

Pag. 57



Art. PTI.503

Telaio bifacciale ricurvo su un lato
2 face curved adjustable inclination
iron frame with net



Pag. 70

Art. AHF-140

Parallelepipedo per pliometria utilizzabile a 3 diverse altezze
Wooden plyometric box
3 different heights



Pag. 141

Art. PTI.732

Rete bersaglio per porta regolamentare
Target net for regular size goal



Art. 090

Lavagna Calcio su treppiede con 100 fogli cm.70x100 (non cancellabili)
Board on tripod with 100 sheets 70x100 cm.
(not erasable)

Pag. 104



Art. FRA

FOOTBALL RACK per l'allenamento dei riflessi del portiere
Football Rack for GK training

Pag. 62



Pag. 62

Art. FW18

FOOTBALL WAVE per l'allenamento dei riflessi del portiere
Football Wave for
GK training

NUOVI PRODOTTI - NEW PRODUCTS

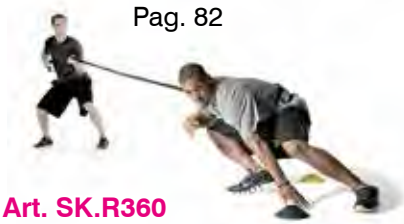

Pag. 82

Art. SK.R360
Recoil 360
 Elastico con cintura
 ad anello scorrevole



Pag. 83

Art. SK.ACTR
Acceleration Trainer
 Trains speed in every direction



Pag. 77

Art. SK.SPSC
Speed Sac
 Sacca di traino
 utilizzabile anche indoor
 Improves speed and explosiveness



Pag. 83

Art. SK.LRP
Lateral Resistor Pro
 Develops first-step quickness
 and lateral speed

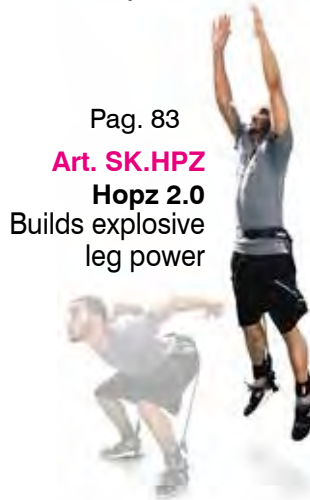

Pag. 83

Art. SK.HPZ
Hopz 2.0
 Builds explosive
 leg power

Art. PTI.STR
Slide Trainer

Pag. 81

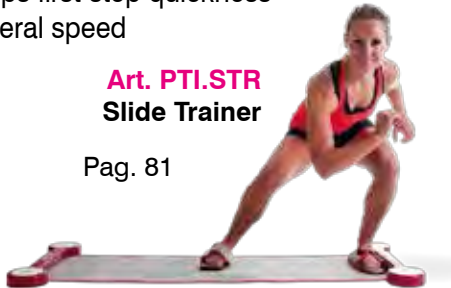

Pag. 170

Art. SK.KOT
KICK-OUT
 Attrezzo Basket
 per ritorno palla
 360° ball return system



Pag. 170

Art. SK.CVS
Occhiali basket a visibilità limitata
 Court vision dribble goggles



Pag. 170

Art. SK.DMAN
Sagoma Basket
 Basket defensive mannequin



Pag. 184

Art. PTI.HB
Lavagna Pallamano
 bifacciale
 Handball tactical board



Pag. 200

Art. PTI.BB
Lavagna Baseball
 bifacciale
 Baseball tactical board



Art. PTI.RU
Lavagna Rugby
 bifacciale
 Rugby tactical board



Pag. 195

Art. PTI.FA
Lavagna
Football Americano
 bifacciale
 Football tactical board

INDICE - INDEX

Attrezzature per la preparazione atletica e specifiche per il Calcio Training and Soccer equipment

Sagome e Barriere - Mannequins and Barriers	pag. 14-25
Barriera filtrante, Barriera con finestre - Reflex Training Device, Window Barrier	pag. 26
Paletti Slalom - Slalom Poles	pag. 27-29
Delimitatori e Birilli - Markers and Cones	pag. 30-34
Ostacoli ad altezza fissa e regolabile - Hurdles fixed and adjustable heights	pag. 35-44
Kit Calcio Tennis - Soccer Tennis kits	pag. 45-48
Forche - Heading Trellises	pag. 50-51
Archi di precisione - Precision Arcs	pag. 49
Muri e Telai con rete - Rebounders and Iron Frames with net	pag. 52-59
Deviatori di traiettoria, Ball Playning - Deviators, Ball Playning	pag. 60-62
Cross Training, Reti con bersagli - Cross Training, Nets with targets	pag. 63;141
Strutture instabili e Tavole Propriocettive, Plinti - Equilibrium Boards	pag. 64-70
Trampolini - Trampolines	pag. 71
Attrezzi speciali, Scalette e Bande elastiche - Special Training tools, Speed Ladders and Elastic Bands	pag. 72-85
Kit tecnico Scuola Calcio - Soccer School kit	pag. 86
Fitness Equipment	pag. 87-94
Casacche, Pantaloncini, Calze, Giacche pioggia, Tubolare Barret, Numeri Termosaldabili - Mesh Shirts, Shorts, Socks, Rain jackets, Tubular hat, Numbers for uniforms	pag. 95-98
Tacchetti ed accessori per scarpe, Lavascarpe - Studs and shoe accessories, Shoe Washing Device	pag. 99-101
Parastinchi, Fasce Capitano, Guanti Portiere - Shinguards, Captain Armbands, GK Gloves	pag. 102-103
Lavagne Tattiche - Tactical Boards	pag. 104-106
Ghiaccio, Tape, Creme, Oli - Ice, Tape, Creams, Oils	pag. 108-109
Materassini, Borracce - Mats, Water Bottles	pag. 107;110
Bandierine e accessori per arbitro - Flags and referee's accessories	pag. 112-115
Pompe, Compressore, Cronometri e Rotelle Metriche - Pumps, Inflator, Chronos	pag. 111;118
Segnalatori manuali ed elettronici per cambio giocatori - Substitution Boards	pag. 116-117
Palloni in pelle ed in gomma - Leather and rubber Balls	pag. 119-122
Palle Mediche, Ritmiche e Psicomotorie - Medicine, Rhythmic and Gym Balls	pag. 123-125
Ceste Portapalloni - Baskets for balls	pag. 128
Borse - Bags	pag. 126-127
Protezioni personali - Protections	pag. 182-183

Attrezzature per lo stadio e lo spogliatoio Stadium and locker room equipment

Porte regolamentari, ridotte, miniporte, porte bifrontali - Official goals, reduced goals, minigoals, 2 side goals	pag. 129-137
Reti regolamentari e ridotte - Nets all sizes	pag. 138-139
Reti di Protezione - Protection Nets	pag. 140
Reti per calci di precisione - Precision shooting nets	pag. 141
Panchine Allenatori - Trainers' Dug-outs	pag. 142-148
Vernice Segnacampo, Carrelli Traccialinee - Ecological Paint, Line Markers	pag. 149-151
Sedute per gradinate e Tribune modulari per interno ed esterno - Stadium seats and Stands	pag. 152-154
Arredi spogliatoio ed infermeria - Locker and infirmary room	pag. 155-160
Tunnel uscita spogliatoi - Stadium Tunnels	pag. 161
Tabelloni elettronici segnapunti - Electronic scoreboards	pag. 185-187
Materassi, Protezioni Murarie - Mats, Wall Protections	pag. 204-206

Altri sport - other sports

Tavoli calcetto - Soccer tables	pag. 163
Basket	pag. 164-171
Volley	pag. 172-177
Minivolley	pag. 178
Beach Volley	pag. 180-181
Beach Soccer	pag. 162
Impianti Multifunzione - Multi purpose systems	pag. 179
Pallamano - Handball	pag. 184
Tennis, Beach Tennis	pag. 188-190
Tennis Tavolo - Table Tennis	pag. 191-193
Badminton	pag. 194
Rugby	pag. 195
Piscina, Pallanuoto - Swimming Pool, Waterpolo	pag. 196-198
Hockey, Baseball	pag. 199-200
Arti Marziali, Boxe - Martial Arts, Boxing	pag. 201-203;207
Ginnastica - Gymnastic	pag. 208-212
Atletica - Track and Field	pag. 213-216
Pilates, Didattica Scolastica, Pattini e Skateboard - Pilates, School Products, Skates	pag. 217-220

INDICE ALFABETICO

Archi di precisione	pag. 49
Arredi spogliatoio ed infermeria	pag. 155-160
Arti Marziali, Boxe	pag. 201-203;207
Aletica	pag. 213-216
Attrezzi speciali, Scalette e Bande elastiche	pag. 72-85
Badminton	pag. 194
Bandierine e accessori per arbitro	pag. 112-115
Barriera filtrante, Barriera con finestre	pag. 26
Basket	pag. 164-171
Beach Soccer	pag. 162
Beach Volley	pag. 180-181
Borse	pag. 126-127
Vernice Segnacampo, Carrelli Traccialinee	pag. 149-151
Casacche, Pantaloncini, Calze, Giacche pioggia, Tubolare Barret, Numeri Termosaldabili	pag. 95-98
Ceste Portapalloni	pag. 128
Cross Training, Reti con bersagli	pag. 63;141
Delimitatori e Birilli	pag. 30-34
Deviatori di traiettoria, Ball Playning	pag. 60-62
Fitness Equipment	pag. 87-94
Forche	pag. 50-51
Ghiaccio, Tape, Creme, Oli	pag. 108-109
Ginnastica	pag. 208-212
Hockey, Baseball	pag. 199-200
Impianti Multifunzione	pag. 179
Kit Calcio Tennis	pag. 45-48
Kit tecnico Scuola Calcio	pag. 86
Lavagne Tattiche	pag. 104-106
Materassi, Protezioni Murarie	pag. 204-206
Materassini, Borracce	pag. 107;110
Minivolley	pag. 178
Muri e Telai con rete	pag. 52-59
Ostacoli ad altezza fissa e regolabile	pag. 35-44
Paletti Slalom	pag. 27-29
Pallamano	pag. 184
Palle Mediche, Ritmiche e Psicomotorie	pag. 123-125
Palloni in pelle ed in gomma	pag. 119-122
Panchine Allenatori	pag. 142-148
Parastinchi, Fasce Capitano, Guanti Portiere	pag. 102-103
Pilates, Didattica Scolastica, Pattini e Skateboard	pag. 217-220
Piscina, Pallanuoto	pag. 196-198
Pompe, Compressore, Cronometri e Rotelle Metriche	pag. 111;118
Porte regolamentari, ridotte, miniporte, porte bifrontali	pag. 129-137
Protezioni personali	pag. 182-183
Reti di Protezione	pag. 140
Reti per calci di precisione	pag. 141
Reti regolamentari e ridotte	pag. 138-139
Rugby	pag. 195
Sagome e Barriere	pag. 14-25
Sedute per gradinate e Tribune modulari per interno ed esterno	pag. 152-154
Segnalatori manuali ed elettronici per cambio giocatori	pag. 116-117
Strutture instabili e Tavolette Propriocettive, Plinti	pag. 64-70
Tabelloni elettronici segnapunti	pag. 185-187
Tacchetti ed accessori per scarpe, Lavascarpe	pag. 99-101
Tavoli calcetto	pag. 163
Tennis Tavolo	pag. 191-193
Tennis, Beach Tennis	pag. 188-190
Trampolini, Cerchi, Corde, Bastoni	pag. 71;75
Tunnel uscita spogliatoi	pag. 161
Volley	pag. 172-177

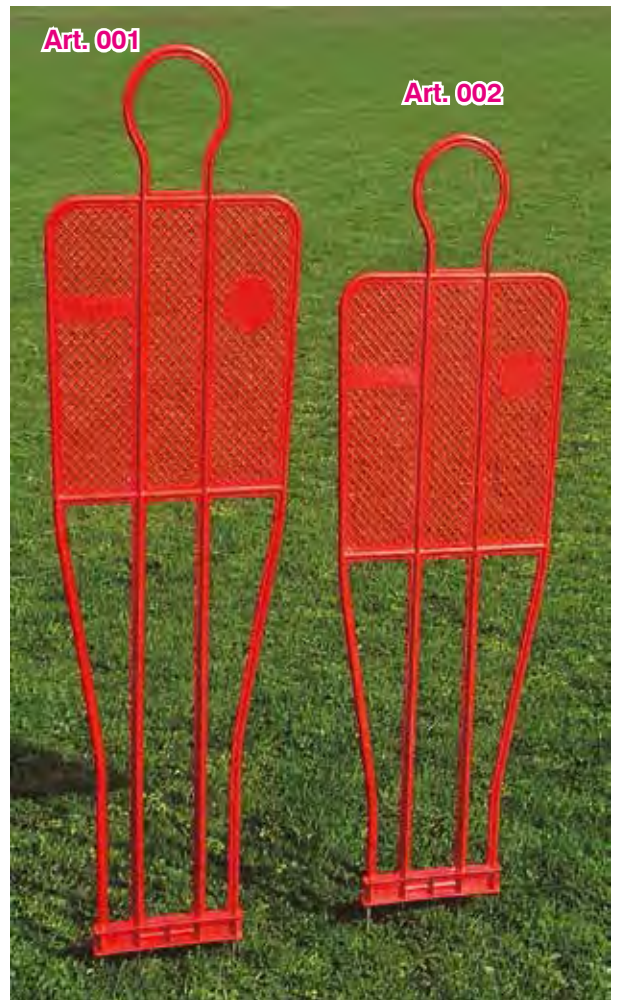

pg.1

**NUOVO MATERIALE PIU' FLESSIBILE!!!
NEW MORE ELASTIC PLASTIC MATERIAL!!!**



Art. 001
Sagoma Barret brevettata
cm. 180 Kg. 3,5
Patented Barret Mannequin
cm. 180 Kg. 3,5

Art. 002
Sagoma Barret brevettata
cm. 160 Kg. 3
Patented Barret Mannequin
cm. 160 Kg. 3

Colori:
Rosso, Blu e Giallo
Colors:
Red, Blue and Yellow

SAGOME BARRET BREVETTATE
leggere, flessibili, super-resistenti,
antifortunistiche!
PATENTED BARRET MANNEQUINS
light, flexible, strong, safe!

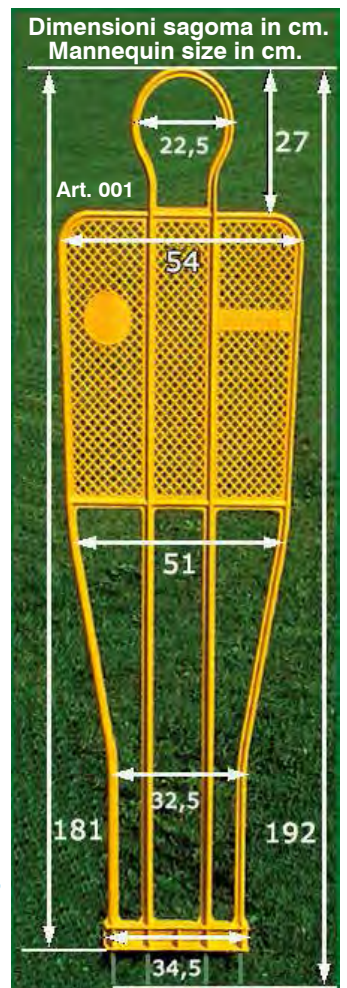

SAGOME E BARRIERE - Barriers

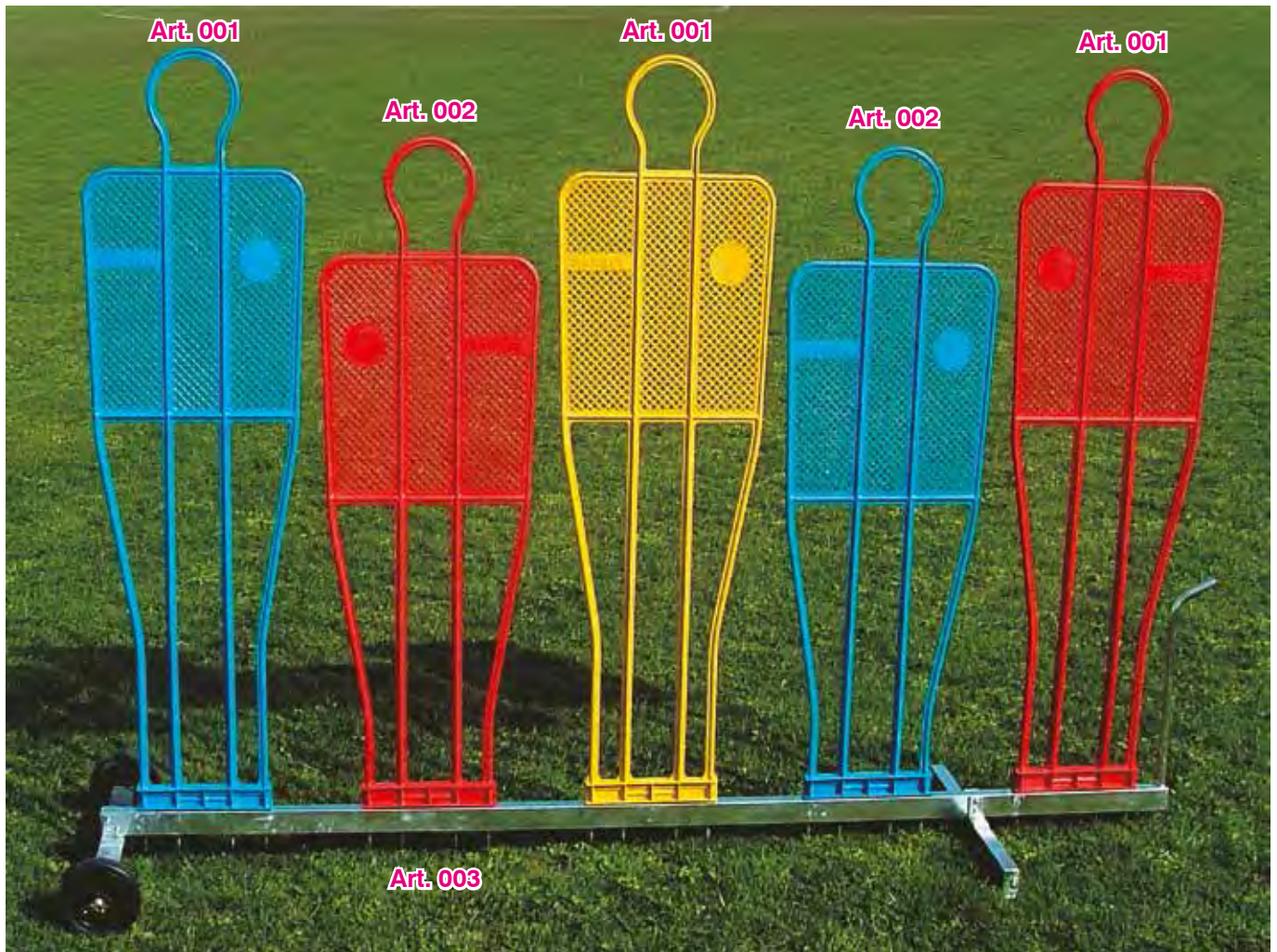

3 x Art. 001 + 2 x Art. 002 + Art. 003
Carrello con 5 sagome - trolley + 5 Barret Mannequins



**4 puntali in acciaio zincato alla base
per posizionamento su
terreno naturale
o su carrello porta sagome**
4 galvanized steel spikes at the base,
for easy positioning on natural grass
or upon Barret trolley



Art. 003 Carrello porta 5 sagome in acciaio zincato con ruote
Trolley for carrying 5 Mannequins in galvanized steel, with wheels



SAGOME BARRET BREVETTATE
indispensabili per:
*calci di punizione, slalom, dribbling,
esercizi di anticipo, uscite aeree,
schemi tattici ...*

PATENTED BARRET MANNEQUINS
very useful for:
*free kicks, slalom, dribbling, tackles,
headers, goal-keeper exercises, tactics ...*



● pg.1

BPS001

**BORSA PORTA 5 SAGOME in nylon impermeabile con tracolla e maniglie,
rinforzi laterali in polipropilene rigido**

Nylon carry bag for 5 mannequins with shoulder belt and handles - waterproof - reinforced on both sides



pg.1

Art. 003RG

Carrello porta 5 sagome in acciaio zincato su ruote - regolabile a 4 altezze (la sagoma Art. 001 può arrivare ad un'altezza massima di cm.225)

Trolley for 5 mannequins in galvanized steel on wheels - 4 adjustable heights (Art. 001 can reach up to 225 cm. height)

Il carrello regolabile in altezza permette la simulazione di giocatori in barriera che saltano al momento del calcio di punizione
This trolley allows free kick practicing by simulating jumping defenders





**Art. 001
+ Art. 003S**

Art. 003S Carrello porta sagoma singola con molle antiribaltamento, in acciaio zincato su ruote

Trolley for single mannequin in galvanized steel with springs, on wheels

pg.1

Il carrello porta sagoma singola Art. 003S impedisce alla sagoma di cadere a terra se colpita dalla palla

Trolley Art.003S allows mannequin to come back straight up when hit by the ball



Art. 003S



Art. 001B

Art. 001B

Base porta sagoma zavorrabile in acciaio zincato, per posizionamento su terreni sintetici

Peso:

kg. 10 vuota, kg. 20 riempita con sabbia

Galvanized steel base to be filled with sand for mannequin positioning on artificial grass.

Weight: 10 kg. empty 20 kg. filled with sand



**Art. 001
+ Art. 001B**



Art. 002R

Art. 001R

Art. 001R

Rivestimento per Sagoma cm. 180 in nylon impermeabile antistrappo con cerniera

Colori: rosso, blu, giallo

Nylon Cover for cm. 180

Mannequin with zip

Colors: red, blue, yellow

Art. 002R

Rivestimento per Sagoma cm. 160 in nylon impermeabile antistrappo con cerniera

Colori: rosso, blu, giallo

Nylon Cover for cm. 160

Mannequin with zip

Colors: red, blue, yellow



5 x Art. 001 + 5 x Art. 001R



**5 x Art. 001 + 5 x Art. 001R
+ Art. 003RG**

pg.1



**LATO POSTERIORE
BACK SIDE**



Art. 001FE
Sagoma Barret
in acciaio zincato
con 4 puntali
altezza cm.180
peso kg.5
 Barret mannequin
 180 cm. height
 in galvanized steel
 with 4 spikes
 weight 5 Kg.

Art. 001FE



Art. 001FE
+ Art. 001B



Art. 001FE
+ Art. 001B
+ Art. 001R

pg.1



Art. 002FE

Sagoma Barret in acciaio
zincato con 4 puntali
altezza cm.160
peso kg.4,5
 Barret mannequin 160 cm.
 height in galvanized steel
 with 4 spikes weight 4,5 Kg.



3 x Art. 001FE + 2 x Art. 002FE
+ 2 x Art. 001R + 2 x Art. 002R
+ Art. 003



Art. 001TD Rivestimento tridimensionale per sagoma Art. 001
h. cm. 180 spessore cm. 20
in PVC monospalmato 360 gr/mq
imbottitura in eliocell d. 16 kg/mc
3D Cover 20 cm. thick
for mannequin Art.001
180 cm. height

I RIVESTIMENTI TRIDIMENSIONALI SIMULANO PERFETTAMENTE IL VOLUME DEL CORPO DEI GIOCATORI PERMETTENDO UNA SERIE DI ESERCIZI TECNICI E TATTICI CON E SENZA PALLA ANCORA PIU' REALISTICI E SICURI. L'IMBOTTITURA E' INOLTRE UTILE PER PROTEGGERE LA SAGOMA DAGLI URTI DELLA PALLA CALCIATA AD ALTA VELOCITA' DURANTE GLI ALLENAMENTI AI CALCI PIAZZATI DI POTENZA



3D COVERS PERFECTLY RESEMBLE PLAYERS' BODIES ALLOWING EVEN MORE REALISTIC AND SAFE TECHNICAL AND TACTICAL EXERCISES WITH AND WITHOUT BALL. THE SOFT SANDWICH PROTECTIONS ALSO AVOID POSSIBLE DAMAGES CAUSED BY HIGH SPEED POWER FREE KICK PRACTISING



pg.1

Art. 002TD Rivestimento tridimensionale per sagoma Art.002
h.cm.160
spessore cm. 20
in PVC monospalmato 360 gr/mq
imbottitura in eliocell d. 16 kg/mc
3D Cover 20 cm. thick
for mannequin Art.002
160 cm. height



Art. GP175

Sagoma in gommapiuma h. cm. 170 - rivestimento in PVC con decorazione digitale fronte-retro del giocatore, zavorrata alla base con sabbia con maniglie per il trasporto colori disponibili: rosso, blu, giallo, arancio, bianco
Ø base cm. 59 - peso kg. 31
 Foam rubber Dummy
 170 cm. height with PVC Cover with player's sketch
 weighted base with sand with handles
 available colors: red, blue, yellow, orange, white
 base Ø 59 cm. - weight 31 kg.

Nessun problema di forature, perdite d'aria o lacerazioni
 No problems with punctures, deflation or lacerations



← **Rivestimento in PVC**
 PVC Cover outside

← **Imbottitura in poliuretano espanso**
 Foam rubber inside

● pg.1

Art. GP205

Sagoma in gommapiuma h. cm. 205 - rivestimento in PVC con decorazione digitale fronte-retro del giocatore, zavorrata alla base con sabbia con maniglie per il trasporto colori disponibili: rosso, blu, giallo, arancio, bianco
Ø base cm. 59 - peso kg. 32
 Foam rubber Dummy
 205 cm. height with PVC Cover with player's sketch
 weighted base with sand with handles
 available colors: red, blue, yellow, orange, white
 base Ø 59 cm. - weight 32 kg.

← **Maniglia su entrambi i lati**
 Handle on both sides

← **Base zavorrata**
 Weighted base

Art. GP175SL
Sagoma in gommapiuma come Art. GP175 solo con logo BARRET (senza la decorazione del giocatore)
 Foam Rubber Dummy same of Art. GP175 but only with BARRET logo (without player's sketch)



Art. GP205SL
Sagoma in gommapiuma come Art. GP205 solo con logo BARRET (senza la decorazione del giocatore)
 Foam Rubber Dummy same of Art. GP205 but only with BARRET logo (without player's sketch)

**NUOVO PVC/PU ANCORA PIÙ RESISTENTE
NEW STRONGER PVC/PU**

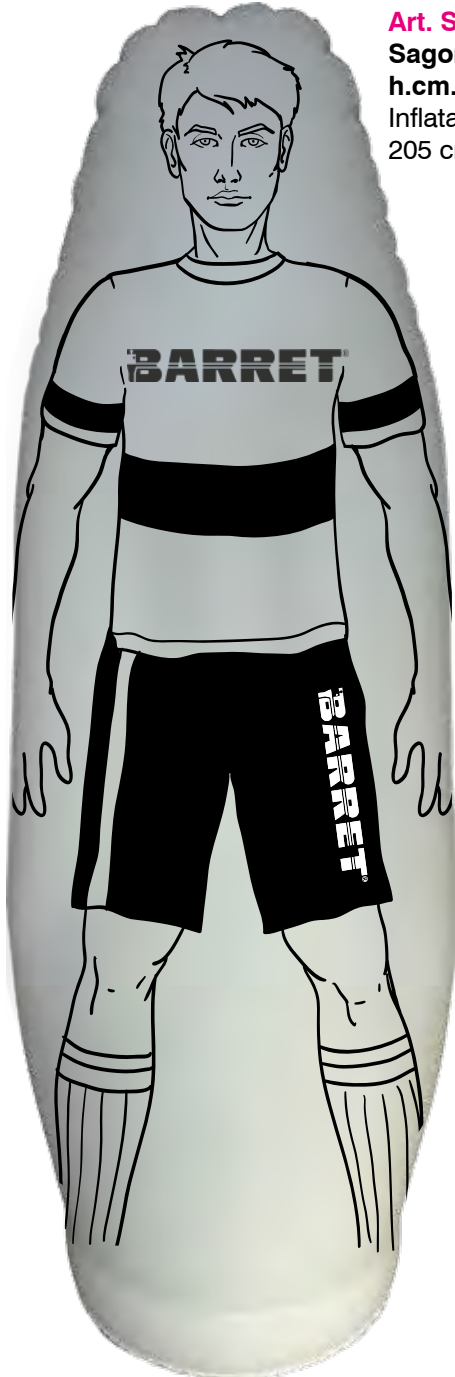

Art. SAG205
Sagoma Gonfiabile
h.cm.205
Inflatable dummy
205 cm. height

Art. SAG175
Sagoma Gonfiabile h.cm.175
Inflatable dummy
175 cm. height

pg.1



Art. SAG115
Sagoma Gonfiabile h.cm.115
Inflatable dummy 115 cm. height

**Ideale per i bambini delle scuole calcio
best for soccer school kids**



Ø base cm. 56 - peso kg. 23
(pronta all'uso)
base Ø 56 cm. - weight 23 Kg.
(when ready for use)

Ø base cm. 45 - peso kg. 11
(pronta all'uso)
base Ø 45 cm. - weight 11 Kg.
(when ready for use)

Ø base cm. 40 - peso kg. 7
(pronta all'uso)
base Ø 40 cm. - weight 7 Kg.
(when ready for use)

Art. KSG Kit di riparazione per sagoma gonfiabile
(n. 1 confezione di collante n. 3 porzioni di rivestimento)
Repairing Kit for inflatable dummies (glue and 3 patches)

Per un ordine minimo di 100 pezzi per misura le sagome gonfiabili possono essere personalizzate
Inflatable dummies can be customized: minimum order 100 pieces for each size

Se colpite dalla palla o dal corpo dei giocatori durante gli esercizi, le sagome gonfiabili Barret tornano in piedi da sole

Barret inflatable dummies always pop back up when hit by ball or players' body during exercises

Nate per l'allenamento dei portieri, le sagome gonfiabili Barret possono essere utilizzate anche per i calciatori per l'effettuazione di una molteplicità di esercizi tecnici e tattici con e senza palla

Born for GK training, Barret inflatable dummies are very useful for lots of tactical and technical exercises involving players with and without ball



Particolare della valvola superiore (rientrante) da utilizzare per il gonfiaggio della sagoma e della valvola inferiore (anch'essa rientrante) da utilizzare per il riempimento della base di appoggio a terra con acqua
The upper valve to inflate the body with air, the bottom valve to fill the base with water

ISTRUZIONI PER IL GONFIAGGIO E L'UTILIZZO DELLE SAGOME GONFIABILI

IMPORTANTE: QUANDO È IN USO LA SAGOMA NON DEVE ESSERE COMPLETAMENTE GONFIA. IL CORPO DEVE RIMANERE SEMPRE MORBIDO, ED I FIANCHI NON DEVONO ESSERE MARCATAMENTE SPORGENTI VERSO L'ESTERNO RISPETTO ALLA BASE (FIANCHI E BASE ZAVORRATA DEVONO TROVARSI QUASI IN LINEA RETTA GLI UNI RISPETTO ALL'ALTRA)

- 1) Gonfiare la sagoma non completamente
- 2) Tenendo la sagoma distesa a terra, riempire il serbatoio con acqua: quando la sagoma comincia ad inclinarsi verso l'alto, chiudere il tappo del serbatoio e metterla in posizione verticale
- 3) Per la sagoma h. cm. 205 il livello dell'acqua deve arrivare appena sopra il tappo del serbatoio: inclinando la sagoma di 15° si deve vedere una bolla d'aria sulla valvola trasparente. Per la sagoma h. cm. 175, invece, riempire completamente il serbatoio
- 4) Provare a spingere la sagoma lateralmente e osservare come torna in posizione eretta
- 5) Se si vuole che la sagoma si rialzi più velocemente, aggiungere dell'acqua (a discapito del peso) e gonfiare un po'
- 6) Se si gonfia ulteriormente la sagoma, distenderla a terra e fare uscire l'aria in eccesso dal serbatoio dell'acqua (il fondo deve essere piatto, non bombato)
- 7) Una volta trovato l'equilibrio desiderato, la sagoma può essere sgonfiata e rigonfiata (ad esempio, per trasportarla in luogo lontano) senza più svuotare il serbatoio dell'acqua
- 8) Non utilizzare le sagome se la temperatura è più bassa di 5 °C (e in ogni caso non usarle se l'acqua nel serbatoio è ghiacciata)
- 9) Non colpire le sagome con corpi appuntiti, non avvicinarle a fonti di calore, non trascinarle ma sollevarle sempre quando occorre spostarle, non sbatterle violentemente a terra
- 10) Per le riparazioni utilizzare l'apposito kit o Loctite 406 (altri prodotti non hanno efficacia sul materiale) Il prodotto è garantito solo per un utilizzo diligente che rispetti le istruzioni fornite



Real Zaragoza S.A.D. Ciudad Deportiva



Sempre in piedi
Pop up dummies



USER'S INSTRUCTIONS

IMPORTANT: WHEN USING YOUR DUMMY YOU ALWAYS HAVE TO KEEP THE BODY VERY SOFT, AND HIPS HAVE TO BE IN A STRAIGHT LINE WITH THE BASE (THEY MUST NOT BE ROUNDED)

Inflatable dummies are entirely made of soft PVC/PU: there are no rigid parts, so these products are absolutely safe. First, you have to inflate your dummy but not completely. Then, by keeping it lying on the floor, you have to fill the tank with water: when the dummy rises up, close the valve and place it upright.

For dummies 205 cm. high the water level must reach just over the valve, while for dummies 175 cm. high the tank can be filled completely.

If you want your dummy to rise up more quickly when hit, add some water and inflate the body a little more. In this case, let the dummy lie on the floor for a while and let some air out from the tank (the base must be flat, not rounded). Dummies can be used both on natural and artificial grass, on turf, gym floors etc.

Two side handles made of soft PVC are very useful to carry your dummy around: it is important to always lift your dummy when you need to move it (never pull it!) so the base doesn't get scratched.

Do not use dummies if the temperature is lower than 5 °C (and in any case do not use them if the water in the tank is frozen).

It is also available a kit for repair when inflatable dummies get damaged because used in wrong ways, in example when they are torn apart by players kicking with their studs against them.



Indistruttibili!
Unbreakable!



pg.1

Art. 706244
Sagoma in plastica rinforzata antiurto su carrello a 4 ruote
altezza cm.190
peso totale Kg.22
(kg.7 la sagoma - Kg.15 il carrello)
spessore sagoma cm.9
Mannequin in reinforced plastic
9 cm. thick with 4 wheel trolley
height 190 cm. weight 22 Kg.

LATO ANTERIORE
FRONT



pg.1

Art. 5026
Sagoma Barret
in vetroresina
h. cm. 185
Fiberglass
Mannequin
185 cm. height

LATO POSTERIORE
BACK



Indistruttibili!
Unbreakable!

4 puntali in acciaio zincato alla base, per posizionamento su terreno naturale o su carrello portasagome

4 galvanized steel spikes at the base, for quick positioning on natural grass or on trolley



Art. 001SP
Sagoma Morbida telo PVC forato antivento con 2 Paletti in PVC h. cm. 170
Soft pierced antiwind PVC Mannequin with 2 PVC Poles 170 cm. high

Art. 001SP3
Sagoma Morbida telo PVC forato antivento con 2 Paletti in PVC h. cm. 130
Soft pierced antiwind PVC Mannequin with 2 PVC Poles 130 cm. high

Art. 001SPA
Sagoma Morbida telo PVC forato antivento con 2 Paletti in alluminio h. cm. 170
Soft pierced antiwind PVC Mannequin with 2 aluminium Poles 170 cm. high

Art. 001SP6
Sagoma Morbida telo PVC forato antivento con 2 Paletti in PVC h. cm. 160
Soft pierced antiwind PVC Mannequin with 2 PVC Poles 160 cm. high

pg.1



Art. SA001
Supporto per sagoma morbida in ferro verniciato utilizzabile su terreno sintetico
Base in painted iron for positioning any soft mannequin on artificial grass





La palla penetra all'improvviso attraverso le finestre senza perdere velocità

Telo cm.250x173
250x173 cm. sheet

Ball goes through the windows without losing speed

Art. 003WB
BARRIERA CON FINESTRE
per l'allenamento ai calci di punizione e per il miglioramento dei tempi di reazione del portiere in caso di tiri improvvisi

kit completo
WINDOW BARRIER for free kicks and Goal Keeper training to fast and sudden shots complete kit

Art. 003WBS pg.1
STRUTTURA SUPERIORE
barriera con finestre, applicabile al carrello porta sagome Art. 003
Window Barrier UPPER PART to be fixed upon trolley Art. 003



Art. 003RX
BARRIERA FILTRANTE REFLEX **kit completo**
REFLEX FILTERING BARRIER on wheels - complete kit

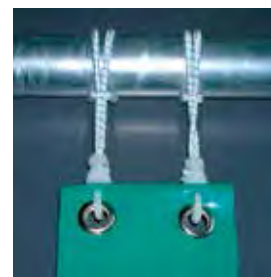

Nuovo sistema di fissaggio
New more resistant elastics and hooks

pg.1

Art. 003RXS
STRUTTURA SUPERIORE barriera filtrante REFLEX, applicabile al carrello porta sagome Art. 003
Reflex Filtering Barrier UPPER PART to be fixed upon trolley Art. 003



Art. 003RXS

Art. 003

INNOVATIVO ATTREZZO FONDAMENTALE PER L'ALLENAMENTO DEI RIFLESSI DEL PORTIERE. LA PALLA (INVISIBILE PER IL PORTIERE AL MOMENTO DEL CALCIO) FILTRA ATTRAVERSO LE STRISCE ED ARRIVA IN PORTA ALL'IMPROVISO ASSUMENDO TALVOLTA TRAIETTORIE IMPREVEDIBILI. ATTREZZO DA POSIZIONARE IN PROSSIMITÀ DELL'AREA PICCOLA

A revolutionary device for goal-keeper's reflex training. The goal-keeper cannot see the ball until it passes through the stripes. The direction of the ball is often unpredictable! To be placed not too far from goal-keeper's area

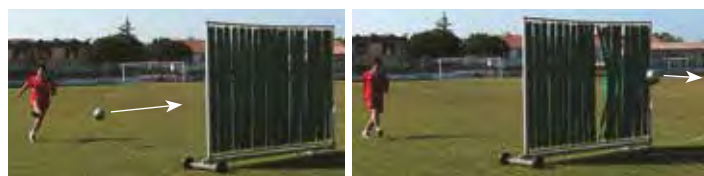

L'ATTREZZO PUO' INOLTRE ESSERE UTILIZZATO COME UNA COMUNE BARRIERA PER L'ALLENAMENTO DEI CALCI DI PUNIZIONE
It is also very useful for free kick practising for both kicker and goal-keeper!



PALETTI SLALOM - Slalom Poles



Art. 007

pg.2

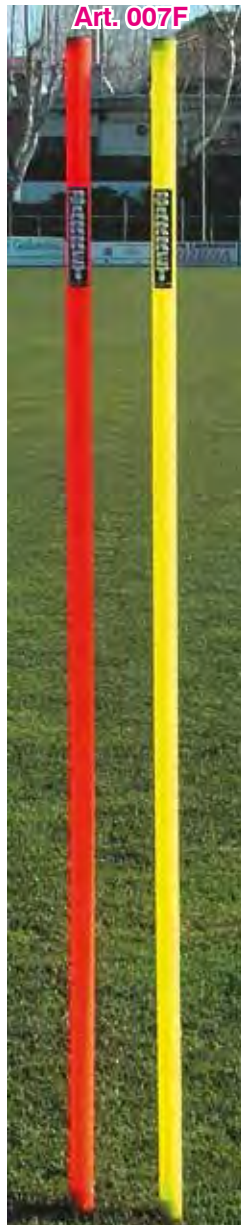

Art. 007F



Art. P007



Colore arancio
Orange colour

New!

Art. 007 Paletto con puntale
cm. 170 - PVC Ø mm. 32
colore giallo, rosso,
bianco, blu, arancio
Pole 170 cm. high in PVC with
galvanized metal spike
colors: yellow, red, white,
blue, orange

Art. 007SP
Paletto senza puntale
cm. 162
PVC Ø mm. 32
colore giallo, rosso,
bianco, blu
Pole 162 cm. high
in PVC
colors: yellow, red,
white, blue

Art. 007F
Paletto in polipropilene
copolimero Ø 32 mm.
h.cm.163
con puntale zincato,
colore giallo o arancio
fluorescente
Slalom Pole 163 cm. height in
copolymer polypropylene
32 mm. with galvanized metal
spike (colors: fluorescent
yellow and orange)

Art. P007
Paletto cm. 160
in polipropilene
Ø mm. 30 con
puntale e piattello
di appoggio,
colore giallo
o arancio
fluorescente
Pole 160 cm. h. in
polypropylene,
metal spike with ring
(colors: fluorescent
yellow and orange)

pg.2

Art. A007



pg.2



Art. A007
Paletto cm. 170
in alluminio Ø mm. 32
con puntale zincato
Pole 170 cm. high
in aluminium with
galvanized metal spike

Art. AS007



Art. AS007
Paletto flessibile
cm. 170 in
alluminio Ø mm.
32 con puntale
zincato e molla
Pole 170 cm. h.
in aluminium with
galvanized metal
spike and spring

Art. S007



Art. S007
Paletto flessibile
cm. 170 in
PVC Ø mm. 32 con
puntale
zincato e molla,
colore giallo o rosso
Pole 170 cm. h.
in PVC with
galvanized metal
spike and spring
colors: yellow, red

Art. 007TL



cm. 170



cm. 90



Art. 007TL
Paletto telescopico
Ø 32 mm
h. cm. 170 in PVC
con puntale zincato
(l'altezza si riduce
fino a cm.90)
colore giallo
Telescopic Pole 170 cm.
h. in PVC with galvanized
metal spike
Height can be reduced
down to 90 cm.
color yellow

pg.2

Art. 007.25
Paletto
cm. 170
smontabile
in PVC
Ø 25 mm
con puntale
zincato svitabile
colore giallo
Dismountable
Pole 170 cm.
height in PVC
with removable
galvanized metal
spike
color yellow





Art. 010

Art. 010
Kit paletto PVC
Ø 32 mm
senza puntale
Art. 007SP
+ base Art. 018
Kit pole without
metal spike
+ base Art. 018



Art. 010C

Art. 010C
Kit paletto PVC
Ø 32 mm
senza puntale
Art. 007SP
+ base Art. 902013
Kit pole without
metal spike
+ base Art. 902013

pg.2



Art. 010WR

Art. 010WR
Kit paletto PVC
Ø 32 mm
senza puntale
Art. 007SP
+ base Art. HWRB
Kit pole without
metal spike
+ base Art. HWRB

Art. SP25
Asta in PVC Ø 25 mm.
altezza cm. 152
PVC pole Ø 25 mm.
height 152 cm.

Art. I-111
Clip rotante
per aste
Ø mm. 25 e 28
Rotating clip
for two pipes
Ø mm. 25 and 28

Art. E21
Traversa cm.120
in PVC Ø mm. 25
Crossbar 120 cm.
in PVC Ø 25 mm.

Art. TAH-X
Base riempibile con
sabbia per aste
Ø 25 mm. e cerchi piatti
o tubolari
Base to be filled with sand
for poles Ø 25 mm.
and flat or tubular hoops

pg.2



Art. HWRB
Base in gomma appesantita
per paletto Ø 32 mm con
o senza puntale
Weighted Rubber base
for pole with
or without metal spike



Art. 018
Base in plastica
per paletto Ø 32 mm
con o senza puntale
Plastic base
for pole with
or without metal spike



Art. 902013
Base cilindrica in plastica
riempibile con sabbia o
acqua, solo per paletto
Ø 32 mm senza puntale
Cylindrical plastic base to
be filled with sand or water,
only for pole without
metal spike



Art. BFT
Borsa porta paletti
(capienza massima 30 pezzi)
Bag containing 30 poles

pg.2

DELIMITATORI - Markers

SPECIFICARE I COLORI RICHIESTI AL MOMENTO DELL'ORDINE
PLEASE, SPECIFY COLORS IN YOUR ORDER



Art. 016

Kit 48 Delimitatori h. cm.5 con rimessaggio
colori disponibili:
giallo fluo, rosso, fucsia, arancio fluo, blu, bianco
Kit 48 Markers h. 5 cm. with holder
(available colors: fluo yellow, red, fuchsia,
fluo orange, blue, white)

Art. 016.1

Kit 48 Delimitatori h. cm.5 senza rimessaggio
colori disponibili:
giallo fluo, rosso, fucsia, arancio fluo, blu, bianco
Kit 48 Markers h. 5 cm. without holder
(available colors: fluo yellow, red, fuchsia,
fluo orange, blue, white)

pg.3



Art. 016.B

Kit 48 Delimitatori h. cm.8 con rimessaggio
giallo fluo, rosso, fucsia, arancio fluo, blu, bianco
Kit 48 Markers 8 cm. height with holder
(fluo yellow, red, fuchsia, fluo orange, blue, white)



Art. 016.R Rimessaggio per delimitatori
h. cm. 8 e delimitatori giganti Art. 016.K
Iron Holder for 8 cm. and giant markers

Art. 016.R5 Rimessaggio per
delimitatori h. cm. 5 e cm. 7
Iron Holder for 5 cm. and 7 cm.
height markers



Art. 016.T



Art. 016.T

Kit 48 Delimitatori h. cm. 7
con rimessaggio
e intagli sulla sommità
colori disponibili: giallo e rosso
Kit 48 Markers with holder 7 cm. height carved on top
(colors: red and yellow)



Art. 016-TDC
Raccoglitore in plastica per delimitatori con manico allungabile
 Adjustable length picking device for markers



pg.3

Art. OSPT15
Delimitatore piatto Ø 15 cm
colori giallo, rosso, arancio
 Flat round Marker Ø 15 cm.
 colors: red, yellow, orange

Ideale per
superfici
sintetiche!
 Great for indoor
 and turf!



pg.3



Art. 015KT
Kit linea + angolo - 24 pz.
 Kit Lines + angles - 24 pieces

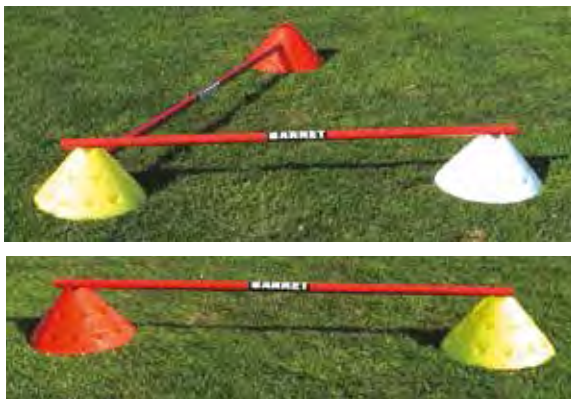

Art. 016.K
Delimitatore gigante con scanalature
Ø cm. 30 h. cm.15 peso gr. 100
colori: giallo, arancio e bianco
 Giant Marker 15 cm. height
 carved on top and sides
 colors yellow, orange and white

Art. 016.K

pg.3



Art. E21

Con l'uso
di traverse
consente
la creazione
di ostacoli
di altezza
cm. 5 / 10 / 15
 Giant markers
 along with crossbars can
 create hurdles
 5-10-15 cm. high



Art. E21 Traversa cm.120 in PVC Ø mm. 25 - colori giallo, rosso, blu, verde, bianco
 Crossbar 120 cm. in PVC Ø 25 mm. colors yellow, red, green, blue, white

pg.3

BIRILLI - Cones

Art. 205000
Birillo calpestabile
in caucciù termoplastico
base Ø cm. 14 - h. cm. 15
colore giallo o rosso
Soft Cone 15 cm. height
14 cm. Ø base
colors red and yellow



Art. HA7
Birillo calpestabile
in caucciù termoplastico
base Ø cm. 17
h. cm. 18
colori giallo e rosso
Soft Cone
18 cm. height and
17 cm. Ø base
colors: red, yellow

pg.4



Art. 019

Art. 019
Kit 24 Maxidelimitatori cm. 28
colori: giallo, arancio, rosso,
royal e fucsia
Kit 24 Maximarkers, height 28 cm.
colors: yellow, orange, red, blue
and fuchsia

Art. 019.1
Maxidelimitatore cm. 28
colori: giallo, arancio, rosso,
royal e fucsia
Maximarker height 28 cm.
colors: yellow, orange, red, blue
and fuchsia

pg.3

Art. 023E
Birillo economico senza fori h. cm. 30
colori rosso e giallo
Light Cone 30 cm. height with no holes
colors: red and yellow

pg.3



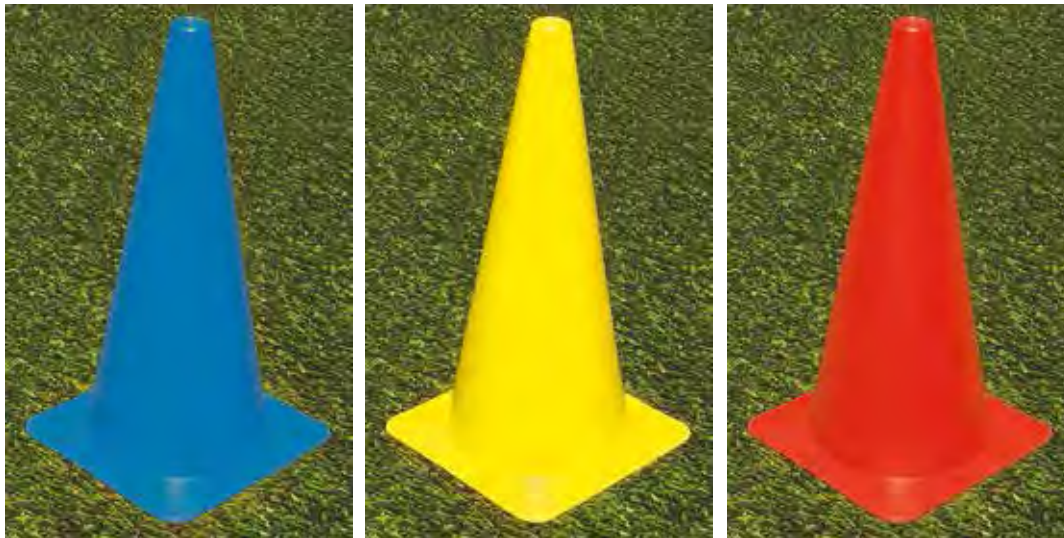

pg.3

Art. 023N

Birillo cm. 38 colore rosso, giallo o blu - Cone height 38 cm. colors: red, yellow, blue

Peso gr. 200 senza foro sulla sommità - Weight 200 gr. with no hole at top



Peso gr. 450
Weight 450 gr.

Art. 023

Birillo giallo cm. 40 con foro sulla sommità
Yellow Cone with hole at the top

pg.4

Art. 025

Birillo fucsia cm. 40 con foro sulla sommità
Fuchsia Cone with hole at the top

Art. 024

Birillo rosso cm. 40 con foro sulla sommità
Red Cone with hole at the top



in 4 colori
in 4 colors

Art. B312

Birillo a 8 fori h. cm. 30 con scanalatura sulla sommità
Cone with 8 holes 30 cm. height carved on top

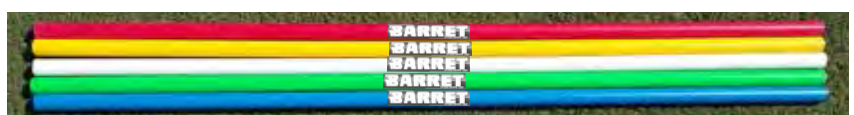

Art. E21 Traversa cm.120 in PVC Ø mm. 25

colori giallo, rosso, blu, verde, bianco

Crossbar 120 cm. in PVC Ø 25 mm. colors yellow, red, green, blue, white



Art. I-111
Clip rotante
per aste
 Ø mm. 25 e 28
 Rotating clip
 for two pipes
 Ø mm. 25 and 28



Art. C21
Birillo a 16 fori
cm. 50 con scanalatura
sulla sommità
in 4 colori
 Cone with 16 holes
 height 50 cm.
 carved on top
 in 4 colors

● pg.4

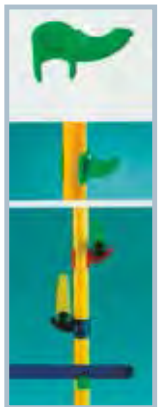

Art. I-110
Clip per montante
Ø mm. 25 e 28
e traversa
 Clip for pipe
 Ø mm. 25 and 28
 and crossbar

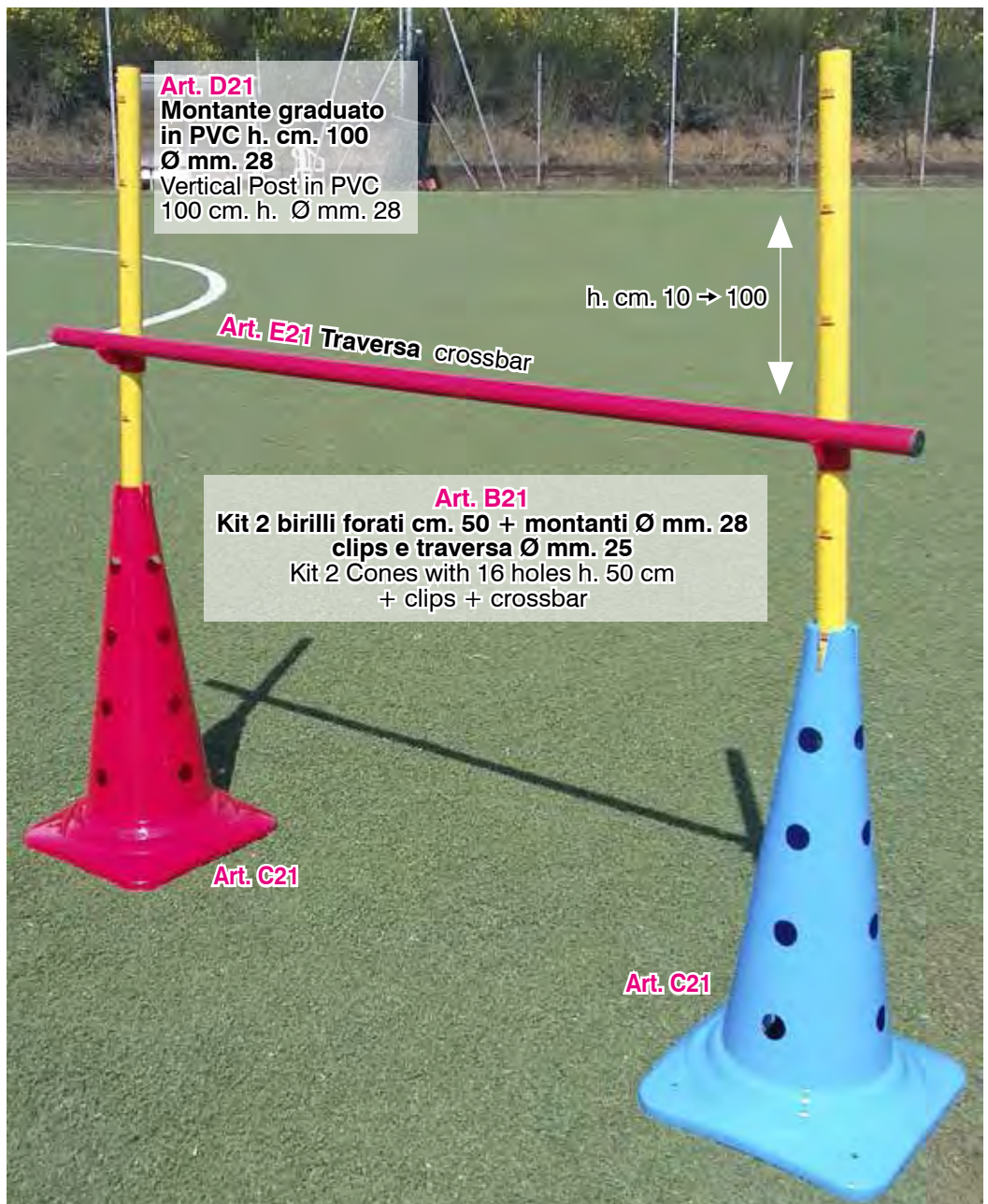

Art. D21
Montante graduato
in PVC h. cm. 100
Ø mm. 28
 Vertical Post in PVC
 100 cm. h. Ø mm. 28

h. cm. 10 → 100

Art. E21 Traversa crossbar

Art. B21
Kit 2 birilli forati cm. 50 + montanti Ø mm. 28
clips e traversa Ø mm. 25
 Kit 2 Cones with 16 holes h. 50 cm
 + clips + crossbar

Art. C21

Art. C21



Art. I-112
Clip per asta
Ø mm. 25 e 28
e cerchio piatto
 Clip for pipe
 Ø mm. 25 and 28
 and flat hoop



Art. 525
Ostacolo regolabile con paletti, ritti e traversa in PVC Ø mm.32
 Hurdle with Poles, clips and crossbar in PVC Ø 32 mm.

pg.3

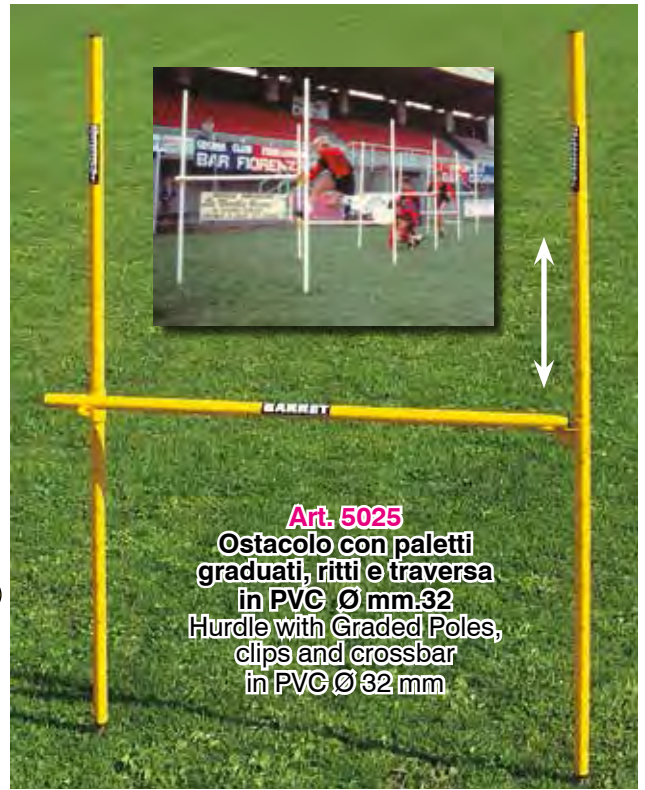

Art. 5025
Ostacolo con paletti graduati, ritti e traversa in PVC Ø mm.32
 Hurdle with Graded Poles, clips and crossbar in PVC Ø 32 mm

h. cm. 10 → 160



Art. 012
Traversa in PVC cm.110 Ø mm. 32
 Crossbar 110 cm. in PVC Ø mm. 32



Art. 012F
Traversa cm. 110 in polipropilene copolimero Ø mm.32 giallo o arancio fluo
 Crossbar 110 cm. in copolymer polypropylene Ø 32 mm. in fluorescent yellow and orange



Art. 525F
Ostacolo regolabile costituito da 2 paletti h 170 cm. con puntale, 1 traversa e 2 clips in polipropilene copolimero colore giallo o arancio fluo
 Hurdle with graded poles, clips and crossbar in copolymer polypropylene Ø 32 mm. (colors: fluorescent yellow and orange)

pg.3

h. cm. 10 → 160



Art. 007SP

Art. ELNR

Art. ELNR
ELASTICO nero con velcro lunghezza cm.135 da fissare ai pali slalom come traversa ad altezza regolabile
 Black band length 135 cm. with velcro to be used as adjustable height crossbar

pg.2

Art. 902013

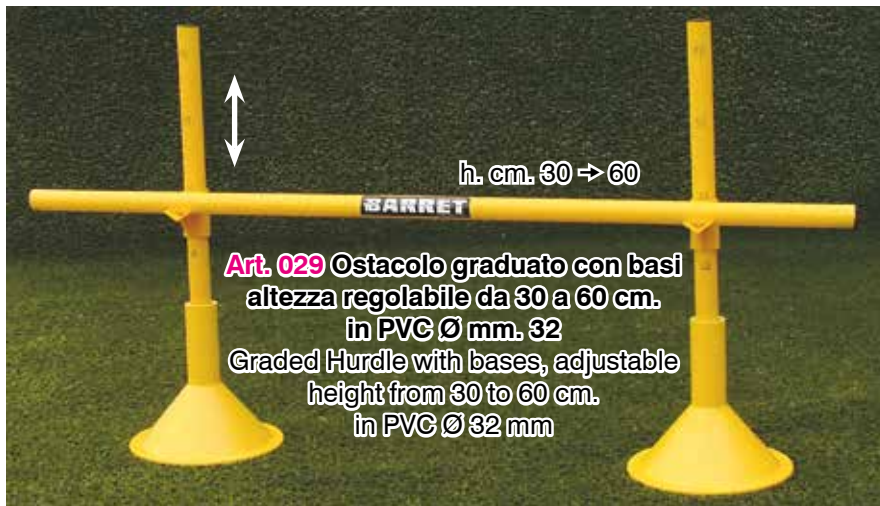

Art. 029 Ostacolo graduato con basi
 altezza regolabile da 30 a 60 cm.
 in PVC Ø mm. 32
 Graded Hurdle with bases, adjustable
 height from 30 to 60 cm.
 in PVC Ø 32 mm

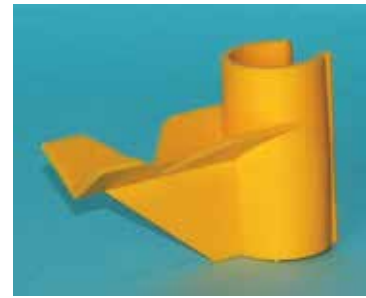

Art. 011
 Clip per sostegno traversa
 per asta Ø mm. 32 o 28
 Clip for crossbar for pipe
 Ø mm. 32 o 28



Art. 030
 Ostacolo graduato con basi
 altezza regolabile
 da 40 a 100 cm.
 in PVC Ø mm. 32
 Graded Hurdle with bases
 adjustable height
 from 40 to 100 cm.
 in PVC Ø 32 mm

pg.3



particolare



pg.2

Art. CL17
 Clip rotante per aste
 Ø mm. 32
 Rotating clip for two
 pipes Ø mm. 32



Art. LL100
 Ostacolo regolabile in PVC costituito
 da 2 montanti Ø mm. 25
 altezza cm. 100
 con basi riempibili con sabbia
 e traversa cm. 100
 Adjustable height PVC Hurdle
 with 100 cm. poles,
 100 cm. crossbar Ø 25 mm.
 bases to be filled with sand

pg.3



particolare

OSTACOLI - Hurdles



pg.5

Art. MH6 / MH9 / MH12
Mini-Over in PVC
altezza fissa,
cm. 15 / 23 / 30
Ideali per i bambini
delle scuole calcio

Mini-Over in PVC
fixed height,
15 / 23 / 30 cm.
Best for soccer
school kids



pg.4

Tornano in posizione
dopo ogni urto
senza danneggiarsi
These hurdles come
back in position after
any hit without being
damaged

Art. 80.12 / 80.14 / 80.16 / 80.18
80.20 / 80.30 / 80.40 / 80.50 / 80.60
Ostacolo Over in PVC
altezza fissa,
cm.12-14-16-18-20-30-40-50-60
Hurdle Over in PVC
fixed height,
12-14-16-18-20-30-40-50-60 cm.

pg.4

Art.
P031-A / P031 / P032
P033 / P034 / P035
Ostacolo Over
in PVC Ø mm. 32
altezza fissa
disponibile
da 12 a 60 cm.
Hurdle Over in PVC
fixed height
available
from 12 to 60 cm.



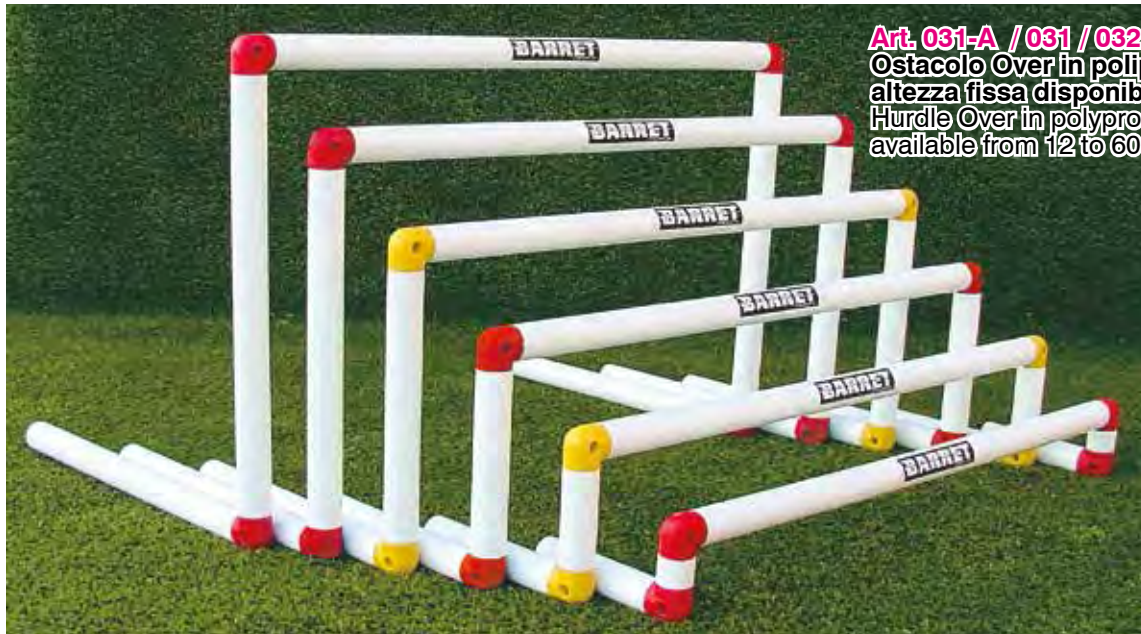

Art. 031-A / 031 / 032 / 033 / 034 / 035
Ostacolo Over in polipropilene Ø mm. 40
altezza fissa disponibile da 12 a 60 cm.
Hurdle Over in polypropylene, fixed height
available from 12 to 60 cm.

Polipropilene
copolimero
Ø 40 mm.
altamente
resistente e
flessibile fino a
-5 gradi!
Polypropylene
copolymer
40 mm. highly
resistant and
elastic till minus
5 degrees!

● pg.5



Art. 235.1 / 235.2 / 235.3 / 235.4 / 235.5 / 235.6
Ostacolo Over
in ferro verniciato altezza fissa
disponibile da 12 a 60 cm.
Hurdle Over in painted iron,
fixed height available
from 12 to 60 cm.



● pg.5

Art. A031-A / A031 / A031-B / A032 / A033 / A034 / A035
Ostacolo Over in alluminio Ø mm. 32 altezza fissa disponibile da 12 a 60 cm.
Hurdle Over in aluminium, fixed height available from 12 to 60 cm.

pg.4

**Art. 031-AF
031F / 031-BF / 032F
033F / 034F / 035F**

**Ostacolo over
altezza fissa
cm. 12-20-30-40-50-60
in polipropilene
copolimero
alta resistenza
Ø mm. 32
colori: giallo e arancio
fluorescente**
Over Hurdle 12 - 20 - 30
40 - 50 - 60 cm. height
polypropylene
copolymer
pipe Ø mm. 32
(colors: fluorescent
yellow and orange)



**Polipropilene
copolimero
FLUO
altamente
resistente e
flessibile fino a
-5 gradi!
Polypropylene
copolymer
fluorescent
highly
resistant and
elastic till minus
5 degrees!**

Art. C031 / C032 / C033 / C034

**Ostacolo Over
con cerniere (richiudibile) in
polipropilene
copolimero Ø mm. 32
colore giallo o arancio
fluorescente
massima altezza
cm. 20 - 30 - 40 - 50
Hinged Hurdle Over
(foldable) in polypropylene
copolymer pipe Ø mm. 32
fluorescent yellow and orange
20 - 30 - 40 - 50 cm.
maximum height**

pg.5



pg.5

Art. P15421

**Serie 5 ostacoli Over supersoft in polietilene
espanso colore giallo, leggerissimi
ideali per uso indoor
altezza cm. 10-20-30-40-50 (il set comprende
un ostacolo per ciascuna altezza)**
Set of 5 Hurdles over supersoft yellow color
very light, best for indoor use
fixed height cm. 10-20-30-40-50



pg.6

Art. 006
Ostacolo con cerniere (richiudibile)
 altezza regolabile da 10 a 60 cm.
 in PVC Ø mm. 32
 Hinged Hurdle (foldable)
 adjustable height
 from 10 to 60 cm. in PVC



pg.6

Art. 006F
Ostacolo con cerniere (richiudibile)
 altezza regolabile da 10 a 60 cm.
 in polipropilene copolimero Ø mm. 32
 colore giallo o arancio fluorescente
 Hinged Hurdle (foldable) adjustable height
 from 10 - 60 cm. in polypropylene
 copolymer pipe Ø mm. 32
 (colors: fluorescent yellow and orange)



pg.6

Art. A004 **Ostacolo con cerniere (richiudibile)**
 altezza regolabile da 10 a 60 cm.
 in alluminio Ø mm. 32
 Hinged Hurdle (foldable) adjustable height
 from 10 to 60 cm. in aluminium



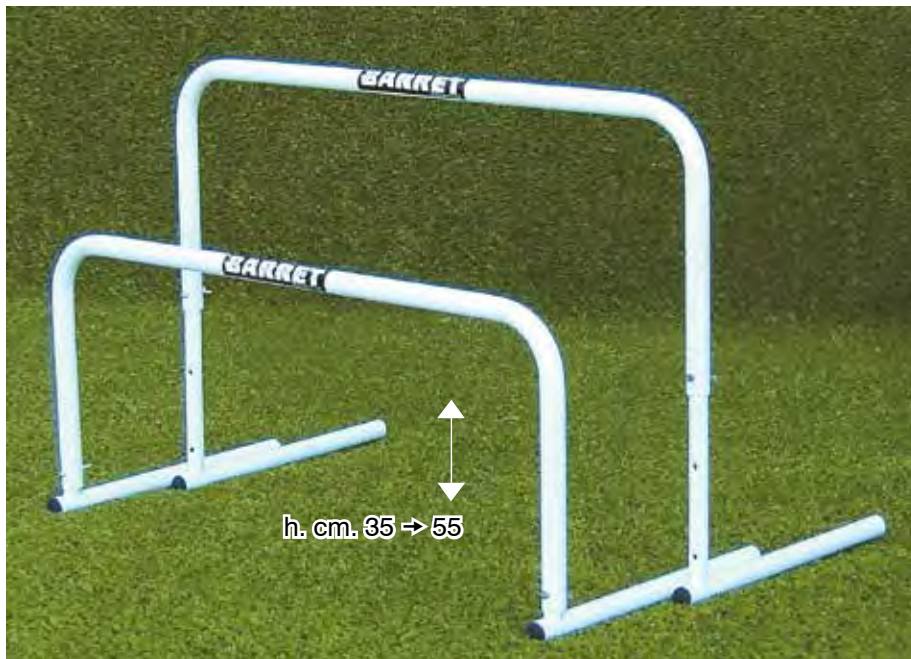

Art. 236
Ostacolo Telescopico regolabile da 35 a 55 cm. in ferro verniciato
Telescopic Hurdle adjustable height from 35 to 55 cm. in painted iron

h. cm. 35 → 55

pg.6

Art. 237
Ostacolo Telescopico regolabile da 60 a 90 cm. in ferro verniciato
Telescopic Hurdle adjustable height from 60 to 90 cm. in painted iron



h. cm. 60 → 90



h. cm. 10 → 50

Art. 036
Mini Ostacolo regolabile da 10 a 50 cm. in plastica
Mini-Hurdle adjustable height from 10 to 50 cm. in plastic

pg.6

IDEALI PER USO INDOOR E PER PALESTRE

For indoor use

Art. P0055
Ostacolo Telescopico graduato, altezza regolabile da 40 a 60 cm. in PVC

Telescopic Hurdle - graded - height adjustable from 40 to 60 cm. in PVC

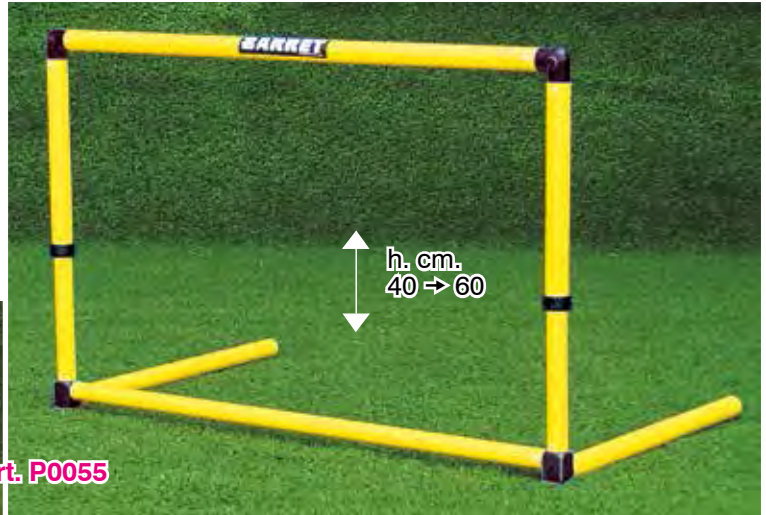

Completamente smontabili, minimo ingombro!
 Dismountable legs, easy to transport

pg.6

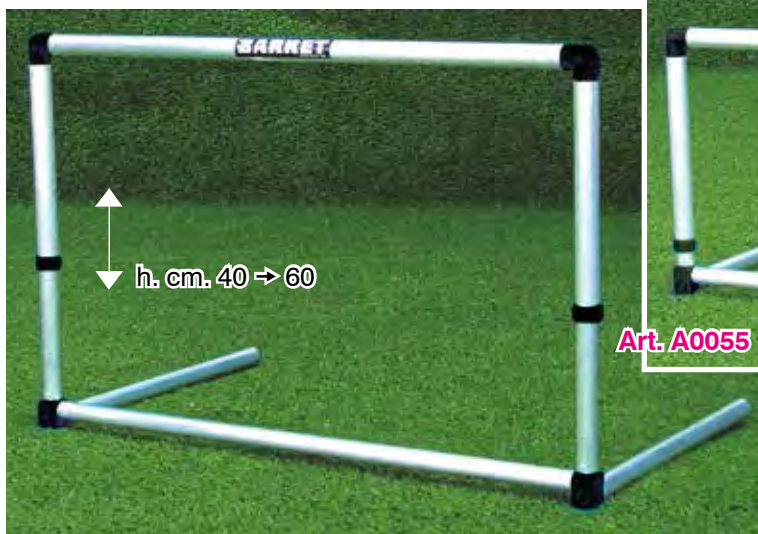

Art. A0055
Ostacolo Telescopico graduato, altezza regolabile da 40 a 60 cm. in alluminio
 Telescopic Hurdle - graded - height adjustable from 40 to 60 cm. in aluminium

Montanti graduati in cm.
 Graded in cm.

Completamente smontabili, minimo ingombro!
 Dismountable legs, easy to transport



Art. P005
Ostacolo Telescopico graduato,
altezza regolabile da 60 a 100 cm. in PVC
 Telescopic Hurdle - graded - height adjustable
 from 60 to 100 cm. in PVC

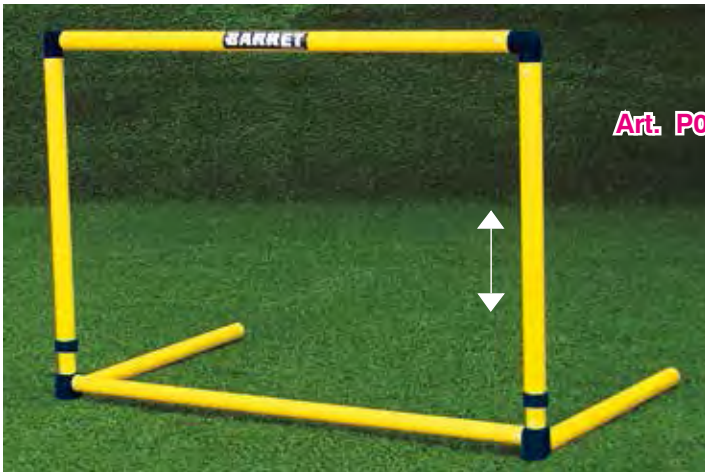

Art. P005

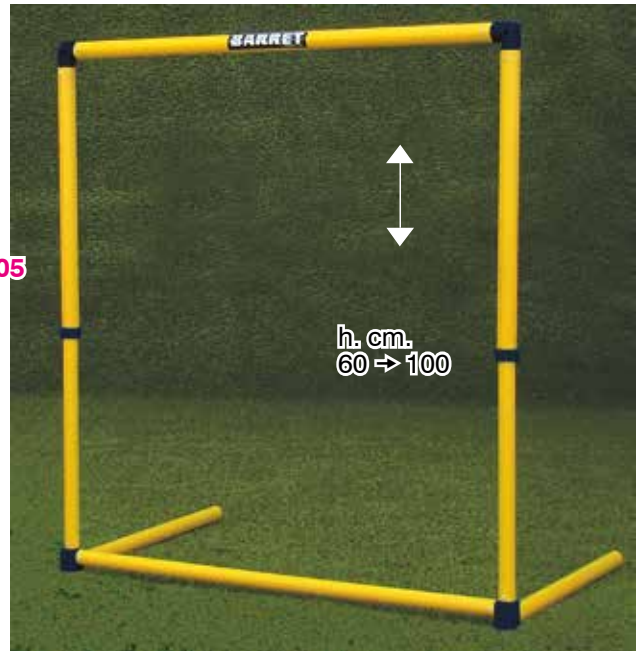

Montanti graduati in cm.
Graded in cm.

Completamente smontabili, minimo ingombro!
 Dismountable legs, easy to transport



Art. A005
Ostacolo Telescopico graduato,
altezza regolabile da 60 a 100 cm. in alluminio
 Telescopic Hurdle - graded
 height adjustable from 60 to 100 cm. in aluminium

pg.6

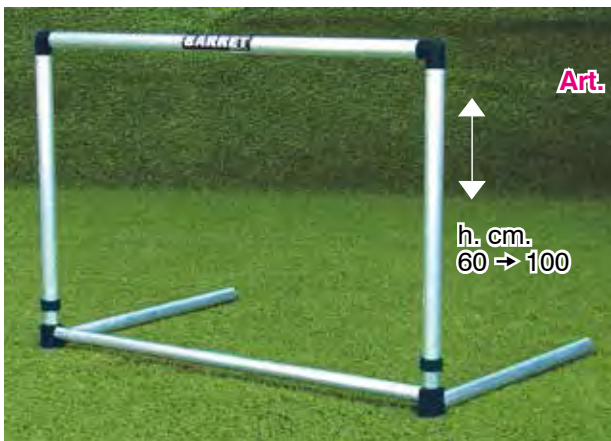

Art. A005



Montanti graduati in cm.
Graded in cm.

Completamente smontabili, minimo ingombro!
 Dismountable legs, easy to transport





**SEMPRE IN PIEDI
DOPO OGNI URTO!
THEY ALWAYS COME
BACK UP AFTER
ANY HIT!**



pg.5

Art. 5020 / 5021 / 5022 / 5023
Ostacolo Basculante in PVC Ø mm. 28
altezza fissa cm. 30 / 40 / 50 / 60
Self-Straightening Hurdle in PVC fixed height,
available in 30 / 40 / 50 / 60 cm.

pg.5

Art. A5020 / A5021 / A5022 / A5023
Ostacolo Basculante in alluminio Ø mm. 28
altezza fissa cm. 30 / 40 / 50 / 60
Self-Straightening Hurdle in aluminium
fixed height, available in 30 / 40 / 50 / 60 cm.



**SEMPRE IN PIEDI
DOPO OGNI URTO!
THEY ALWAYS COME
BACK UP AFTER
ANY HIT!**



KIT CALCIO TENNIS - Soccer Tennis Kits

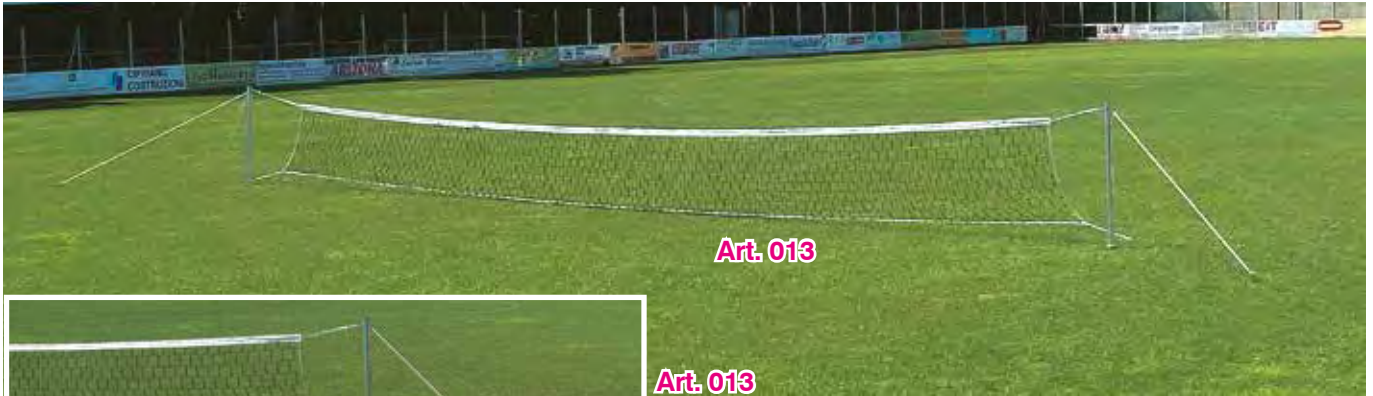

Art. 013



Art. 013

Kit Calcio Tennis pali in alluminio sezione 60 mm. completo di rete mt. 9, tiranti, picchetti e delimitazione utilizzabile solo su terreni naturali

Soccer Tennis Kit aluminium poles 60 mm. with 9 meter net, tightening ropes, pegs and tape for bounds - for natural grass

pg.6



Art. 014

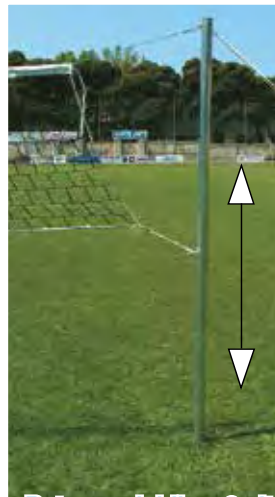

Art. 014
Kit Calcio Tennis pali in alluminio sezione 60 mm. completo di rete mt. 9 regolabile a 3 altezze (cm. 110/170/230) con tiranti, picchetti e delimitazione utilizzabile solo su terreni naturali
Soccer Tennis Kit aluminium poles 60 mm. with 9 meter net adjustable at 3 different heights, tightening ropes, pegs and tape for bounds - for natural grass



Rete regolabile a 3 altezze
Adjustable height net

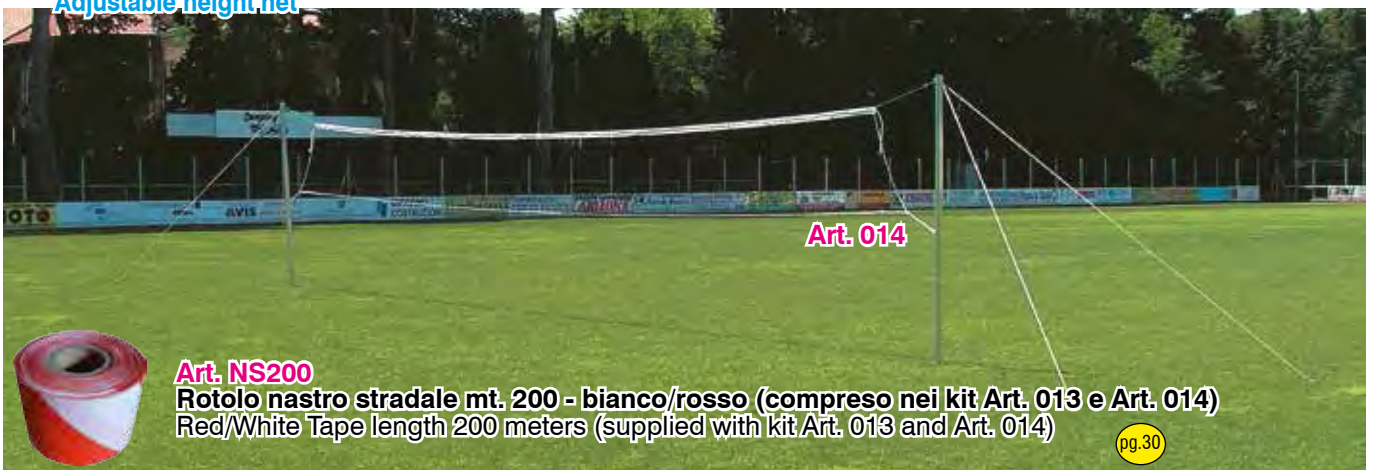

Art. 014



Art. NS200

Rotolo nastro stradale mt. 200 - bianco/rosso (compreso nei kit Art. 013 e Art. 014)
Red/White Tape length 200 meters (supplied with kit Art. 013 and Art. 014)

pg.30



Art. 013.N
Kit Calcio Tennis pali in PVC
completo di rete mt. 3,30
tiranti e picchetti
per terreni naturali
Soccer Tennis Kit PVC poles
with 3,30 meter net
tightening ropes and pegs
for natural grass

pg.6



Art. 013.G Kit calcio tennis pali in PVC
con rete mt.10 - altezza cm.130
con tiranti, picchetti e sacca
per terreni naturali
Soccer Tennis Kit PVC poles
10 meter long 130 cm. height net with
ropes, steel hooks and bag
for natural grass



pg.6

Art. 013.P
Kit calcio tennis
con rete mt. 3
utilizzabile anche
su terreni sintetici
o indoor
con sacca
Soccer Tennis Kit
3 meter net - with bag
also for artificial
grass or indoor

Art. 013.SP

Kit calcio tennis con rete cm.

450x170

**utilizzabile anche
su terreni sintetici o indoor**

con sacca

Soccer Tennis Kit 4,5x1,7 meter net
with bag, also for artificial grass
or indoor



pg.6

Art. 013.60

Kit calcio tennis

con rete cm. 600x90

**utilizzabile anche
su terreni sintetici**

o indoor con sacca

Soccer Tennis Kit
6,0x0,9 meter net
with bag, also
for artificial grass
or indoor



Art. 013.S

Kit Calcio Tennis TATTICO

pali in polipropilene

**completo di rete in PVC mt. 2,30 regolabile in
altezza, tiranti e basi in ferro verniciato**

utilizzabile anche su terreni sintetici o indoor

Soccer Tennis Kit polypropylene poles
with adjustable height PVC net 2,30 meter long,
tightening ropes and painted steel bases
also for artificial grass or indoor

**Nasconde per qualche istante la visione
del pallone, determinando risposte a livello
neuromuscolare e migliorando cinestesia e
sensibilità nel tocco di palla**

This Soccer Tennis Kit hides the ball from
player's visibility stimulating neuro muscular
reflexes and improving ball control

pg.6



Art. 013.SB

Borsa per Kit calcio tennis

Art. 013.S

Bag to carry soccer tennis
kit Art. 013.S





Art. T10076
Coordinatore di Frequenza / Calcio tennis
lunghezza m. 5 utilizzabile anche su superfici sintetiche
attrezzo sicuro, privo di picchetti in metallo
 Speed Ladder / Soccer Tennis Kit
 length 5 meters - also for indoor or artificial grass
 safe without any metal spikes

Ideale per i bambini delle scuole calcio
best for soccer school kids



ARCHI DI PRECISIONE - Precision passing arcs

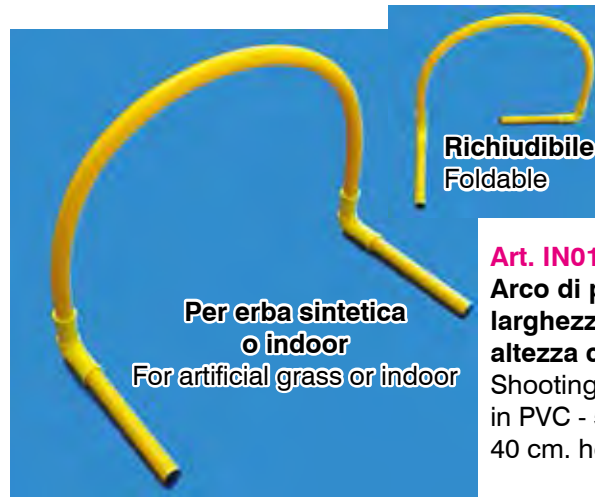

pg.6



Art. 020 / 021 / 022
Arco di precisione in polipropilene
Ø 40 mm. cm. 45x45 / 40x40 / 35x35
Shooting/Passing Arc
in polypropylene Ø 40 mm.
dim. 45x45 / 40x40 / 35x35 cm.



Art. A020 / A021 / A022
Arco di precisione
in alluminio Ø 32 mm.
cm. 45x45 / 40x40 / 35x35
Shooting/Passing Arc
in aluminium Ø 32 mm.
dim. 45x45 / 40x40 / 35x35 cm.



FORCHE - Heading Trellises



Art. F203

pg.6

Art. F203

**Forca doppia
in ferro verniciato
telescopica, smontabile
bussola inclusa
altezza da terra cm. 300
(palloni esclusi)**
Double Heading Trellis
in painted iron
telescopic, dismantable,
underground socket included,
height 300 cm. off ground
(balls not included)



pg.6

Art. 037F

**Forca singola
in acciaio zincato,
con zavorra,
per erba sintetica o indoor
altezza da terra cm.300
(pallone escluso)**
Single Heading Trellis
in galvanized iron weighted for
artificial grass or indoor
height 300 cm. off ground
(ball not included)



Art. ULTVE5

**Pallone per forca
Trial n. 5
in gomma
doppio strato
gr. 420
Ø cm. 21,5**
Trial rubber Ball
for Heading trellis
size 5
double stratum

pg.7

Art. ULTVE4

**Pallone per forca Trial n. 4
in gomma doppio strato gr. 250 Ø cm. 20**
Trial rubber Ball for Heading trellis size 4 double stratum



Art. 038
Forca doppia
in alluminio
tubo sezione 60 mm.
altezza da terra cm.300
(palloni esclusi)
 Double Heading Trellis
 in aluminium
 pipe section 60 mm.
 300 cm. height off ground
 (balls not included)

pg.6

Art. B038
Bussola per forca
(optional)
 Underground socket
 (optional)



pg.7

Art. 039.4 / 039.5
Pallone per
forca in pelle sintetica
disponibile mis. 4 e 5
 Ball for Heading Trellis,
 in synthetic leather
 available size 4 and 5



pg.10

Con questo attrezzo
è possibile verificare
giornalmente i
miglioramenti
nell'elevazione
degli atleti
 This instrument tests
 players' daily jump
 improvements

Art. HJT Head Jump Tester - strumento polivalente di misurazione
ed allenamento, permette la valutazione delle qualità muscolari
degli arti inferiori, dell'elevazione dei giocatori, del loro modo di
colpire la palla di testa e dell'ampiezza del tuffo del portiere
 Instrument that allows the training and measurement of jump ability of
 players and goal-keepers

MURI - TELAI CON RETE - Rebounders - Iron frames with nets



Vista frontale
Front view



Vista laterale
side view

Art. 5011

Muro per allenamento portieri in vetroresina montato su 4 ruote
Fiberglass Goal-Keeper Rebounder on 4 wheels

pg.7

Dimensioni:
altezza cm.200
larghezza cm.130
Peso Kg.100

Dimensions:
height 200 cm.
width 130 cm.
weight: 100 Kg.

Calciando o lanciando la palla verso il muro essa assumerà direzioni di rimbalzo imprevedibili, favorendo l'allenamento dei riflessi del portiere

By kicking or throwing the ball against the wall it will rebound in different directions, testing and training GK's reflexes



Vista posteriore
Back view

Consente l'allenamento con o senza il preparatore atletico
goalkeeper can exercise by himself as well



Con superficie superiore a semisfere e superficie inferiore liscia
Upper side with hemispheres and smooth lower side



Kg. 50



Art. 5010

Muro per allenamento giocatori a 3 facce in vetroresina montato su 3 ruote

3 side Fiberglass Players' Rebounder on 3 wheels
Dimensions: 1,3 m. width x 1,1 m. height every side weight 50 Kg.



pg.7



Art. 5050

Muro allenamento giocatori a 2 facce di cui una ad inclinazione regolabile, interamente in vetroresina montato su 4 ruote

2 side Fiberglass Player's rebounder on 4 wheels
one side can be inclined



Kg. 50



Dimensioni:
m. 1,3 larghezza x m. 1,1 altezza
ciascuna faccia
peso Kg. 50

Dimensions:
1,3 m. width x 1,1 m. height
every side
weight 50 Kg.

Attraverso l'utilizzo della parete regolabile è possibile determinare traiettorie di risposta della palla verso l'alto al fine di sollecitare il tiro al volo, il colpo di testa ed il controllo di palla
Thanks to the adjustable inclination you can get an upward ball rebound and train acrobatic shooting, headers and ball control

Art. MP501N

Muro prismatico in vetroresina a 3 facce lisce di dimensioni cm.107x140 - cm.107x120 - cm.107x108 - peso Kg.48 - con asole per il trasporto
****utilizzabile contemporaneamente da due lati ed in 4 diverse posizioni****

3 side Fiberglass Players' Rebounder with side dimensions 107x140 cm. - 107x120 cm. - 107x108 cm. weight 48 Kg. with slots for transport
****allows 4 different training positions on both sides simultaneously****

pg.7



Permette di ottenere la più ampia varietà di rimbalzi e traiettorie, utili per il miglioramento del controllo di palla, del passaggio, del tiro a volo e del colpo di testa

1

Posizione "in piedi" con 3 facce perpendicolari al terreno di gioco
Standing position with all sides perpendicular to the ground

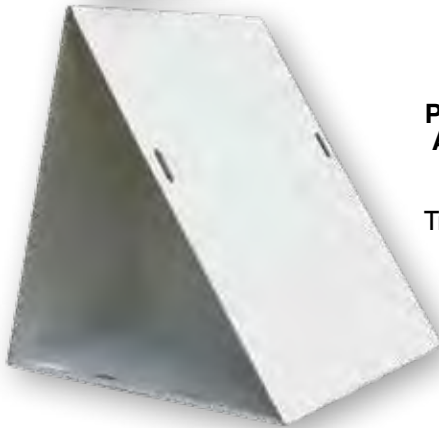

2

Posizione con base a terra cm.107x108
Allenamento con superfici di rimbalzo ad inclinazione alta e medio-alta
Position with 107x108 cm. base
Training with high and medium inclination rebounding sides

Allows the widest variety of rebounds in order to improve ball control, passing and shooting

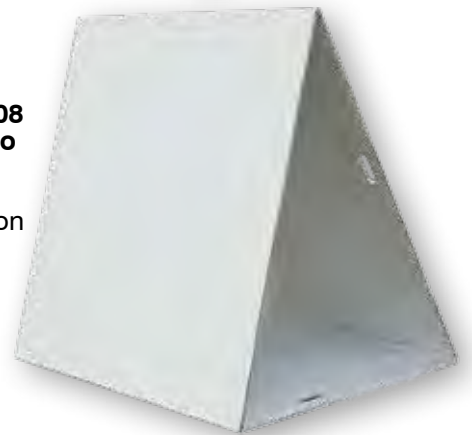

3

Posizione con base a terra cm.107x120
Allenamento con superfici di rimbalzo ad inclinazione alta e bassa
Position with 107x120 cm. base
Training with high and low inclination rebounding sides



Rinforzo interno per l'ottimizzazione del rimbalzo
Internal reinforcement for rebound improvement

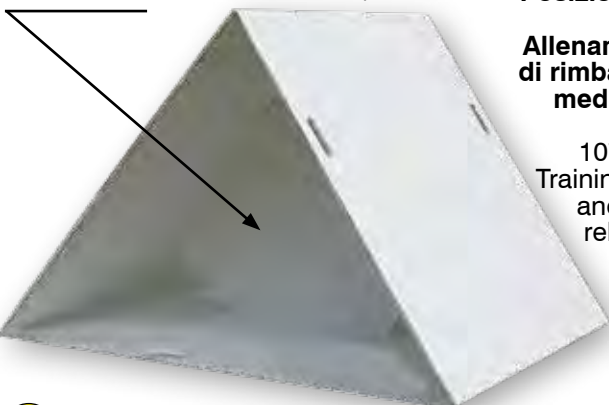

4

Posizione con base a terra cm.107x140
Allenamento con superfici di rimbalzo ad inclinazione medio-bassa e bassa
Position with 107x140 cm. base
Training with medium-low and low inclination rebounding sides

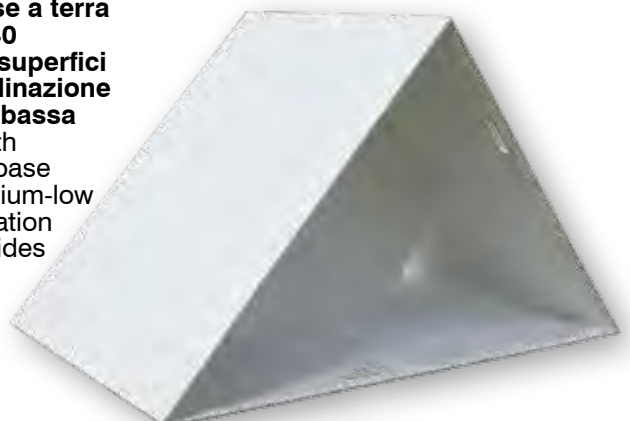

Art. PLRB16

**Muro prismatico in vetroresina a 3 facce lisce
larghezza cm.135 - altezza massima cm.62
con asole per il trasporto - peso kg.24**

****utilizzabile contemporaneamente da due lati ed in 3 diverse posizioni****

3 side Fiberglass Players' Rebounder
width 135 cm. - maximum height 62 cm
with slots for transport - 24 kg. weight

****allows 3 different training positions on both sides simultaneously****

pg.7

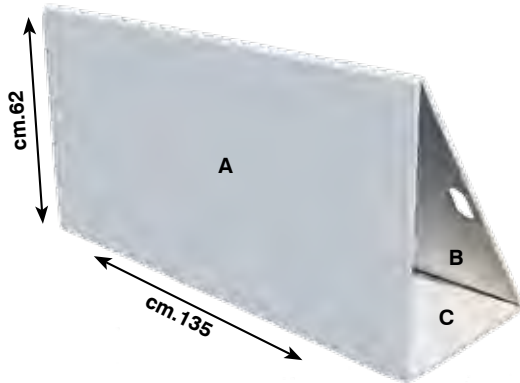

1

**Posizione con superficie A perpendicolare
al terreno e superficie B molto inclinata**
Position with 90 degrees A side and high inclination B side

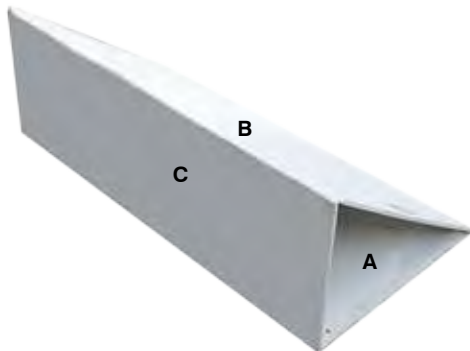
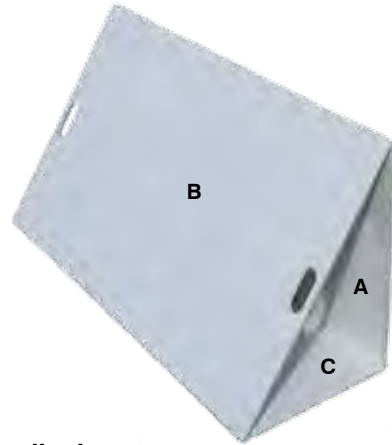

2

**Posizione con superficie C perpendicolare
al terreno e superficie B inclinata**
Position with 90 degrees C side and low inclination B side

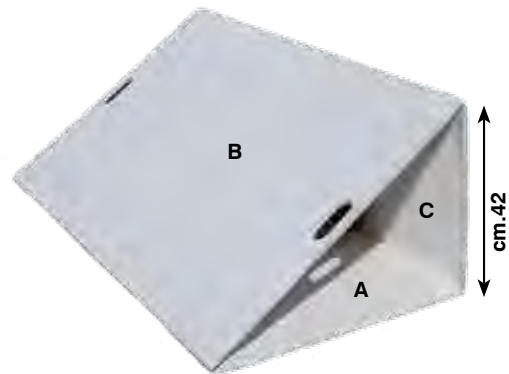

3

**Posizione con superfici A e C
a diversa inclinazione**
Position with A and C sides differently inclined

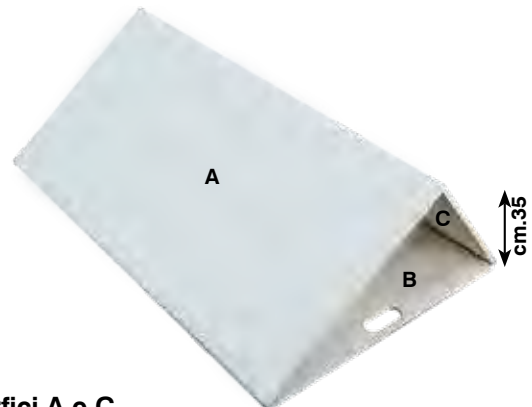
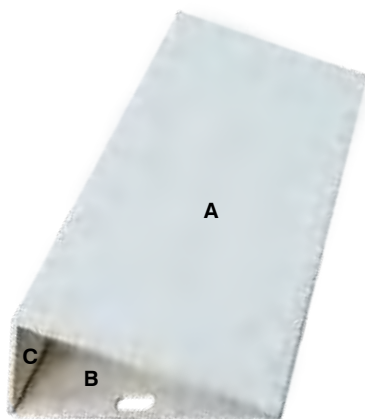

**Permette di ottenere la più ampia
varietà di rimbalzi e traiettorie, utili
per il miglioramento del controllo di
palla, del passaggio, del tiro a volo
e del colpo di testa**

**Rinforzo interno
per l'ottimizzazione del rimbalzo**
Internal reinforcement for rebound improvement

**Allows the widest
variety of rebounds in
order to improve ball
control, passing and
shooting**



pg.7

Art. PAL PAL ORIGINAL - Kit 3 pannelli orientabili in legno finlandese trattato a 5 strati rivestiti in gomma, completo di 4 aste metalliche di fissaggio, 6 pomelli di sicurezza e 1 martello per il fissaggio

Pal Original - Kit 3 rebounding sides in Finnish multi stratum wood covered with rubber, with 4 metal pegs, 6 safety protections and 1 hammer

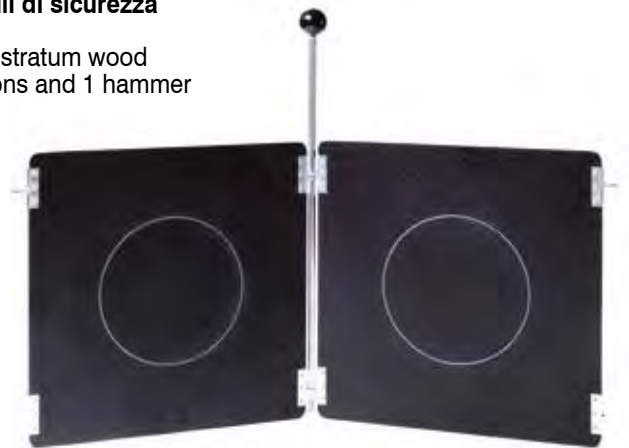
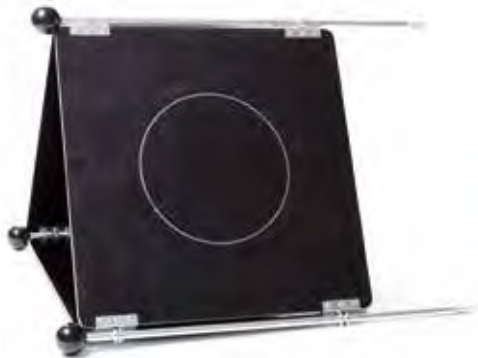

Ideale per l'effettuazione di esercizi individuali e di gruppo volti al miglioramento della coordinazione motoria, del controllo di palla, del passaggio, del tiro e del gioco aereo
Very useful for individual and group exercises to improve coordination, ball control, passing and shooting



pg.7

Art. TM001

Muro triangolare in legno multistrato marino, trattato con vernice impermeabilizzante dimensioni lato cm.150x50

Attraverso l'uso in posizione verticale è possibile determinare traiettorie di risposta della palla verso l'alto al fine di sollecitare il tiro a volo, il colpo di testa e lo stop

Triangular rebounder made of marine wood treated with special paint against humidity - side size 150x50 cm.

By placing it in vertical position you will receive an upward ball rebound to train acrobatic shooting, header and ball control.



Art. PTI.503

Telaio con rete in acciaio verniciato, bifacciale ricurvo su un lato ad inclinazione regolabile dimensioni cm. 111x105x63

2 face adjustable inclination iron frame with net for goal-keepers and players size 111x105x63 cm.

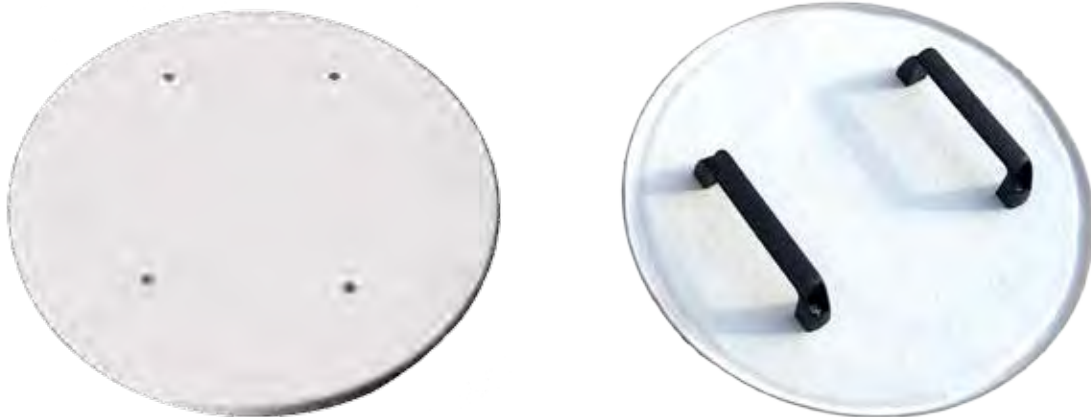

Art. SCVR16

Disco in vetroresina con maniglie per l'allenamento della reattività del portiere sulle deviazioni da tiro o colpo di testa ravvicinato diametro cm.47 peso kg.2

Fiberglass Discus with handles for close shot and deflection GK training - diameter 47 cm. weight 2 kg.

● pg.7



Art. 5030.T

Telaio con rete in alluminio dim. cm.90 x 70 ad inclinazione regolabile con maniglie impugnabili dall'allenatore.

Consente la simulazione di colpi di testa e tiri acrobatici per un allenamento alternativo del portiere

Aluminium frame with net size 90x70 cm. adjustable inclination with handles for trainer to simulate headers and acrobatic shooting trajectories for new GK exercises



Art. 5035G Telaio con rete cm.105 x 105
in ferro zincato ad inclinazione regolabile,
per allenamento portieri e giocatori
Iron frame with net in galvanized iron
dimensions 105x105 cm. adjustable inclination
for goal-keepers and players



Art. 5030
Telaio con rete cm. 130 x 130
in ferro verniciato ad
inclinazione regolabile

Painted iron frame with net,
dimensions 130x130 cm.
adjustable inclination

● pg.7



con picchetti
di ancoraggio
with anchoring
hooks

Art. 503.BF
Telaio con rete in ferro verniciato, bifacciale a doppia inclinazione,
altezza cm.150 larghezza cm.100
con picchetti per fissaggio a terra,
per allenamento portieri e giocatori

Iron frame with net,
in painted iron 2 sides
double inclination
height 150 cm.
width 100 cm.
with anchoring hooks
for goal-keepers and players



kg. 25

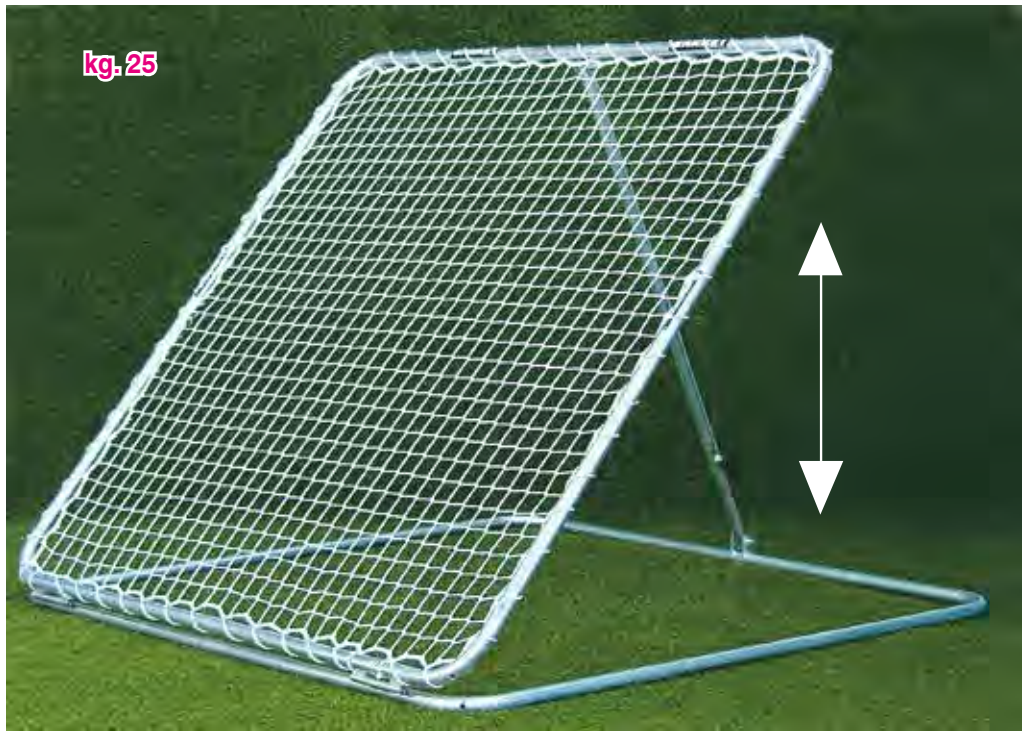

Art. 5040
Telaio con rete
cm. 140 x 140
in ferro zincato
ad inclinazione regolabile,
per allenamento
portieri e giocatori
Iron frame with net in
galvanized iron dimensions
140x140 cm.
adjustable inclination
for goal-keepers
and players

pg.7



kg. 55

Art. 5041
Telaio con rete cm. 315 x 230
in ferro zincato
ad inclinazione regolabile,
per allenamento portieri e giocatori
Iron frame with net, in galvanized iron dimensions 315 x 230 cm. adjustable inclination for goal-keepers and players



Art. 4640
Coppia ruote gommata per
un agevole trasporto del
telaio Art. 5041 (optional)
Pair of wheels for Art. 5041
(optional)



Video dimostrativo disponibile su www.barretsport.com

Video available at www.barretsport.com

Art. DT01
Deviatore di traiettoria
 Tubi in alluminio, con cerniere e piedini di stabilità.
 Coadiuvano l'allenamento quotidiano del portiere ed il suo eventuale recupero post traumatico
BREVETTATO
 SHOT DEVIATOR - pipes in aluminium, with hinges and stability pegs - very useful to improve GK reactivity and to accelerate injury recovery
PATENTED

Brevettato
Patented

pg.7

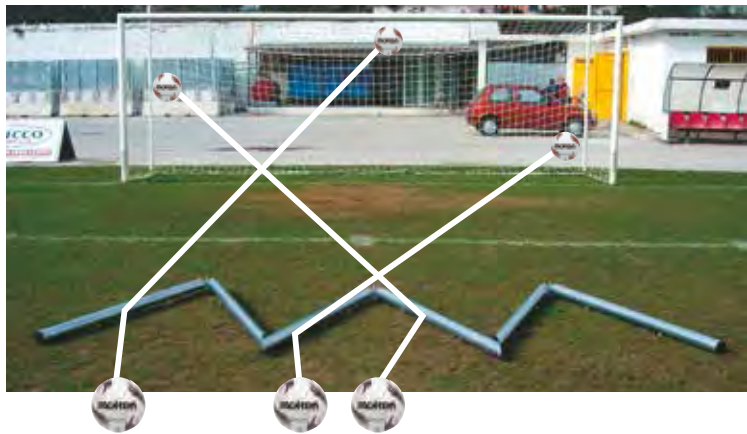

Borsa per il trasporto inclusa
Bag included

Si consiglia di inumidire l'erba di fronte all'attrezzo per incrementare la velocità della palla calciata rasoterra prima dell'impatto con il Deviatore
 We recommend to wet the grass in front of the training device in order to let the ball hit the deviator at a higher speed



Video dimostrativo disponibile su www.barretsport.com

Video available at www.barretsport.com

Art. BP63
BALL PLAYNING Modello Mundial - telo in PVC con rilievi gonfiabili e riempibili con acqua per l'allenamento dei riflessi del portiere metri 5 x 2,5 - completo di borsa e pompa per il gonfiaggio
 Ball Playning Mundial for GK training in PVC size 5 x 2,5 meters with air and water bubbles, complete with pump and bag



pg.7

Prodotto ideato e brevettato da Mario Quaglieri, preparatore portieri professionista



Bagna il Ball Playning prima dell'uso per incrementare la velocità della palla!
 Always wet your Ball Playning to increase ball speed!



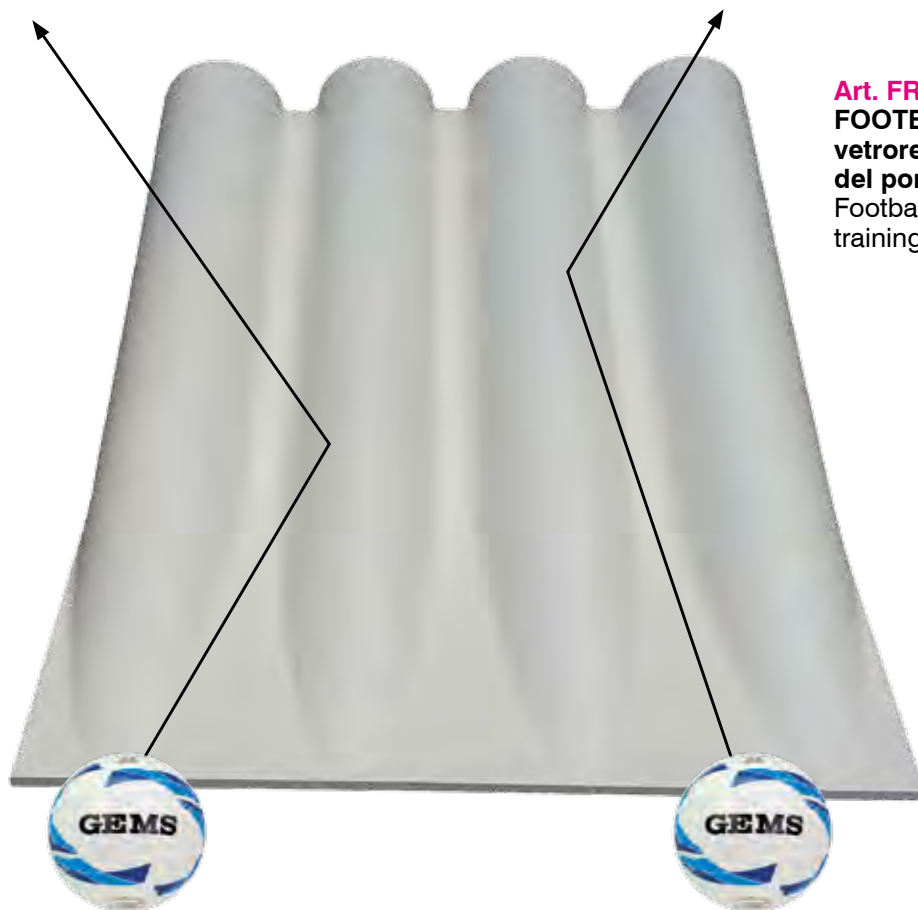

Art. FRM16
FOOTBALL RAMP - attrezzo in vetroresina per l'allenamento dei riflessi del portiere sui tiri ravvicinati e deviati
Football Ramp - fiberglass deviator for GK training to close highly deflected shots

Bagna il Football Ramp prima dell'uso per incrementare la velocità della palla!
Always wet your Football Ramp to increase ball speed!

pg.7

dimensioni: cm.150x110 ad inclinazione regolabile per mezzo di due piedi telescopici
dimensions: 150x110 cm. adjustable inclination by means of two telescopic feet



pg.7



Art. BDV15
Cuspide in vetroresina appesantito con cemento, dimensioni cm.56x21x21h per allenamento dei riflessi del portiere
Fiberglass cusp with concrete filling
dimensions 56x21xh21 cm. for GK training

Posizionando una serie di cuspidi nell'area piccola si ottengono deviazioni della palla improvvise, utili per l'allenamento dei riflessi e della reattività del portiere
Train goal keeper's reactivity to sudden and close deflections by placing a number of cusps near the GK's area



Art. FRA

FOOTBALL RACK - attrezzo in ferro zincato per l'allenamento dei riflessi del portiere sui tiri ravvicinati e deviati
dimensioni cm.160x54 - peso kg. 13
Football Rack - galvanized iron deviator for training of GK reflexes on close and deflected shots
size 160x54 cm. - weight 13 kg.

pg.7



Art. FW18

FOOTBALL WAVE - attrezzo in policarbonato per l'allenamento dei riflessi del portiere sui tiri ravvicinati e deviati
dimensioni cm. 90x60 - peso kg. 5
Football Wave - polycarbonate deviator for training of GK reflexes on close and deflected shots
size 90x60 cm. - weight 5 kg.



Bagna il Football Wave prima dell'uso per incrementare la velocità della palla!

Always wet your Football Wave to increase ball speed!

Inclinazione regolabile per mezzo di due piedi telescopici

Adjustable inclination by means of two telescopic feet

Più Football Waves possono essere posizionati contemporaneamente sul terreno per ottenere effetti imprevedibili

You can place more than one Football Wave on the pitch to get unpredictable deflections





Art. QBF
CROSS TRAINING - rete bersaglio
sempre in piedi per allenamento
alla precisione del cross,
del lancio in profondità,
del rinvio del portiere

CROSS TRAINING - always standing
movable target to improve crossing,
long passing and GK kicks precision

Il bersaglio ha dimensioni cm.120x120, ha una
inclinazione regolabile da orizzontale a quasi
verticale ed è in grado di ricevere la palla ad
altezze comprese tra cm.190 e cm.250 senza
mai cadere a terra - peso Kg.10 - facilmente
spostabile sul campo

The basket is adjustable from horizontal to nearly
vertical - height adjustable from 190 to 250 cm.
weight 10 Kg. - very easy to move on the field,
never falls down when hit by the ball

PROPRIOCEZIONE - Equilibrium training



Art. 168PC
Tavoletta propriocettiva
in plastica su emisfera,
Ø cm. 41 regolabile
in altezza
Plastic Equilibrium
Board with
hemisphere bottom side
Ø 41 cm.
adjustable height



Art. IS441
Tavoletta propriocettiva in legno
su emisfera, con rivestimento
antiscivolo Ø cm. 40
Wooden Equilibrium Board with
hemisphere bottom side,
Ø 40 cm.
base with anti-skid surface

pg.8

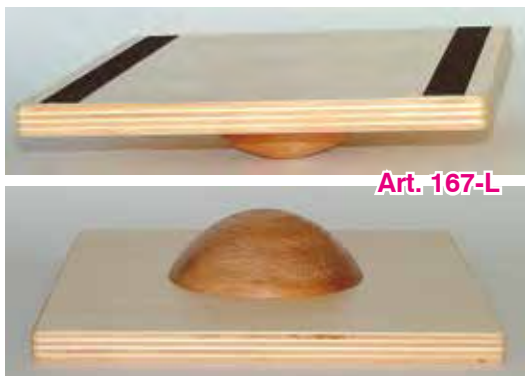

Art. 167-L Tavoletta propriocettiva
in legno su emisfera,
base di appoggio cm. 30x30
Wooden Equilibrium Board with
hemisphere bottom side, base 30x30 cm.

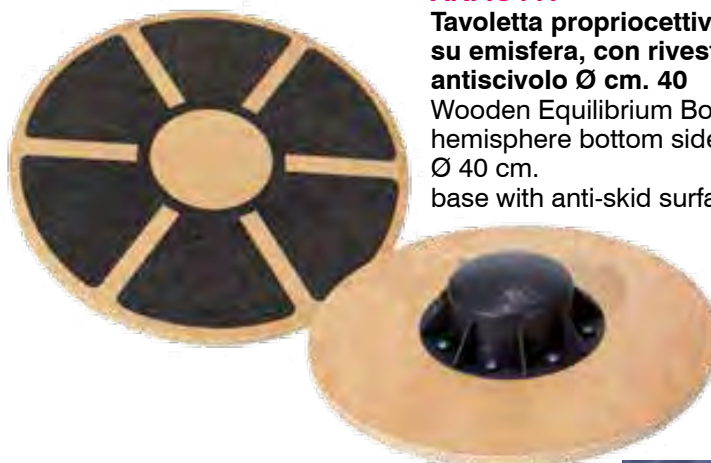

Art. 169-R Tavoletta propriocettiva in legno
su semiluna, base di appoggio cm.60x40
con rivestimento in gomma antiscivolo
Wooden Equilibrium Board, with half moon bottom side,
base dimensions cm.60x40 with anti-skid surface



Art. 167-T Tavoletta propriocettiva in legno
su emisfera, Ø base di appoggio cm. 60
con rivestimento in gomma antiscivolo
Wooden Equilibrium Board with hemisphere
bottom side, base Ø 60 cm. with anti-skid surface



Art. 169-V Tavoletta propriocettiva in vetroresina su
semiluna, base di appoggio cm.60x40
Fiberglass Equilibrium Board, with half moon bottom
side, base dimensions 60x40 cm.



Art. 167-V Tavoletta propriocettiva in vetroresina
su emisfera, Ø base di appoggio cm. 60
Fiberglass Equilibrium Board with hemisphere
bottom side, base Ø 60 cm.



Art. 995201 **PROPRIO FOOT**
Tavoletta propriocettiva in legno situata su una superficie di appoggio gonfiabile
Wooden Equilibrium Board with inflatable bottom side



Art. 995212 **SOMBRERO**
Tavoletta per ginnastica e riabilitazione che combina l'instabilità dell'imbottitura in gommapiuma sul piano di appoggio in legno con le proprietà di una semisfera gonfiabile
Wooden Equilibrium Board with foam rubber on top and inflatable hemisphere on bottom side

pg.8



Art. 995243 **ROLA BOLA** Tavola per l'allenamento dell'equilibrio con superficie antiscivolo - i fermi di sicurezza impediscono al cilindro di scivolare all'esterno
Wooden Equilibrium Board with anti-skid on top
The cylinder never slips out of the board thanks to the security wood pieces on bottom side



Art. AIR.OC
Air step gonfiabile completo di maniglie con elastici
Inflatable Air Step handles and elastics included



Art. TBEFS
BLOCCO PER STRETCHING tendineo e muscolare (flessori caviglia e coscia, dorso etc.) con appoggio soffice e sagomato a 2 inclinazioni ideale per il defaticamento e per il recupero
STRETCHING BLOCK for ankle, leg, back muscles and tendons - with soft double inclination very good for after-training exercises



Art. MH9T / MH16T Semisfera gonfiabile Trial per riabilitazione e stimolazione propriocettiva diam. cm. 9 o cm. 16
Inflatable hemisphere for rehabilitation Ø 9 or 16 cm.



pg.8



Art. FTN-DB
Cuscino gonfiabile puntinato Ø cm 32,5
Inflatable cylinder for rehabilitation Ø cm 32,5



Art. FY8911
Cuscino gonfiabile puntinato Ø cm 39
Inflatable cylinder for rehabilitation Ø cm 39



Art. C1
Pedana Cilindrica gonfiabile Trial Skimmy per riabilitazione e stimolazione propriocettiva dim. cm.32,5x6
Inflatable cylinder for rehabilitation dim. 32,5x6 cm.

pg.8



Art. C2
Pedana Cilindrica gonfiabile Trial Super Skimmy per riabilitazione e stimolazione propriocettiva, dim. cm.40x9
Inflatable cylinder for rehabilitation dim. 40x9 cm.



Resistenti ai tacchetti
Stud proof



Art. C3
Pedana Trial Super Skimmy Professional con spalla rinforzata per riabilitazione e stimolazione propriocettiva, gonfiabile cm.40x9
Inflatable cylinder 40x9 cm. reinforced on sides





Art. C11
Pedana Rotante 1
 dim. cm 32,5x6
 kg 2,3
 (inclusa pompetta
 per il gonfiaggio)
 Rotatory disk 1
 pump included



Art. C22
Pedana Rotante 2
 dim. cm 40x10
 kg 4
 (inclusa pompetta
 per il gonfiaggio)
 Rotatory disk 2
 pump included



Le Pedane Rotanti Trial, grazie al particolare meccanismo rotante, consentono di creare un'infinita varietà di esercizi basati su diverse posizioni di appoggio e modalità di movimento, utili a stimolare contemporaneamente il sistema vestibolare e quello visivo sensoriale, agendo quindi su tutti i sistemi di controllo del movimento sia a livello nervoso centrale che su quello spinale medio e periferico

Rotatory Proprioceptive Disks Trial, given the particular rotating mechanism, allow a great variety of exercises based on different positions and motions, useful to simultaneously stimulate the vestibular and the sensory visual systems at both central and spinal/peripheral nervous levels

pg.8

Art. C4
Rebound Disk - diametro cm.40
altezza cm.4 - Kg.1,5 colore rosso
 40 cm. diameter - 4 cm. thick - 1,5 Kg.



Rebound Disk Trial è una nuova pedana ideale per allenare contemporaneamente la forza muscolare e la proprioccezione. È adatta sia all'uso indoor che outdoor, anche con scarpe tecniche munite di tacchetti. In particolare, con Rebound Disk è possibile sfruttare l'altezza per effettuare esercizi combinati pliometrici (cadute ed ammortizzamento con e senza rimbalzo) e propriocettivi, consentendo all'utente un'esperienza coordinativa e di potenziamento neuromuscolare notevole. Il salto, così come la corsa, è un elemento fondamentale in moltissimi sport come calcio, pallamano, beach-handball, basket, volley, e Rebound Disk è particolarmente allenante per il salto con arresto e cambio di direzione

Rebound Disk Trial is a new tool ideal to simultaneously train muscle strength and proprioception.

It's suitable both for indoor and outdoor utilization, even with technical shoes (with studs).

In particular, with Rebound Disk it's possible to exploit one's height for plyometric exercises (fall and dampen with or without rebound) and for proprioceptive ones, and the user is enabled to experience a remarkable coordination and neuromuscular strengthening. Jumping, as well as running, is a basic element in many sports such as soccer, handball, beach-handball, basketball, volleyball, and Rebound Disk is very effective in training jump with stop and direction changes

**Art. T1 Medusa Trial - struttura instabile base Ø cm. 45
 altezza cm. 23 per riabilitazione e stimolazione
 equilibrio, in gomma doppio strato
 massima instabilità**
 Medusa for rehabilitation
 and equilibrium training
 double stratum rubber
 Ø 45 cm. base
 height 23 cm.

**Resistente
 ai tacchetti
 Stud proof**

pg.8



**Resistente ai
 tacchetti
 Stud proof**

**Art. T3
 Pedana instabile
 con base inferiore
 antiscivolo
 Ø cm. 55
 altezza cm. 15
 studiata per
 i campi sintetici,
 specifica per
 i più giovani**
 Unstable Medusa
 with anti-skid bottom
 55 cm. Ø base
 height 15 cm.
 ideal for artificial
 grass and young
 players

pg.8



**Art. T1.1
 Medusa Trial Ø cm.45
 altezza cm. 23
 con piatto rigido
 alla base
 per conferire
 maggiore stabilità**
 Medusa 45 cm. Ø base
 height 23 cm.
 with rigid bottom for
 better stability



**Resistente
 ai tacchetti
 Stud proof**



**Nuova maniglia
 New handle**



pg.8



**Art. T2 Tartaruga Trial - struttura instabile base Ø cm. 65 altezza cm. 24
 per riabilitazione e stimolazione equilibrio, in gomma doppio strato**
 Medusa double stratum rubber Ø 65 cm. base height 24 cm. - for rehabilitation and equilibrium training

New!



Art. AHF-182
Pedana BOSU Ø cm.58
con tiranti elastici e maniglie
completa di pompa per il gonfiaggio
Bosu ball Ø 58 cm. with handles
and elastic straps, pump included



Art. TCRAZY
TCR.T2
CRAZY HORSE
per allenamento
di equilibrio "estremo"
da effettuarsi in coppia
For extreme balance training

pg.8

New!



Art. 14181
Fettuccia con lunghezza 18 metri per l'allenamento dell'equilibrio. Si fissa facilmente tra due alberi, ed è perfetta per giocare, allenarsi o fare riabilitazione. Kit completo con sacca e paraalberi
18 meter long tape for balance training. It is easily fixed between two trees and is perfect for playing, training or rehab. Complete kit with bag and tree protections

Art. TA-I Coppia tappeti propriocettivi ad isole a 2 densità diverse:
1 tappeto densità gr. 120 con isole densità gr. 30 - 1 tappeto densità gr. 30 con isole densità gr. 120
dimensioni tappeti m.2x1 modulabili con velcro (a formare 1 materasso m.4x1 o m.2x2)
Pair of Mats 2x1 meter each (when together 4x1 or 2x2 meter) :
1 mat 120 gr. density with 30 gr. density round areas, 1 mat 30 gr. density with 120 gr. density round areas

pg.8

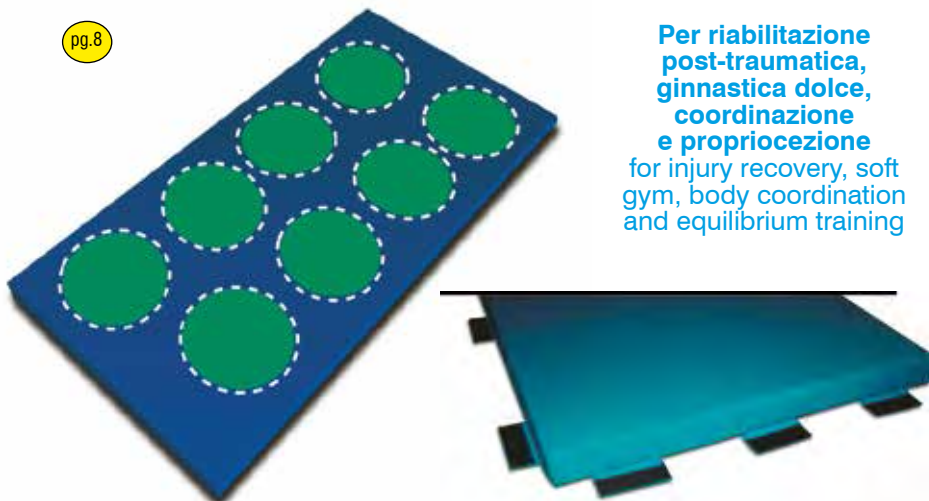

Per riabilitazione post-traumatica, ginnastica dolce, coordinazione e propriocezione
for injury recovery, soft gym, body coordination and equilibrium training





Art. V9178
Plinto per pliometria regolabile in altezza da cm. 30 a cm. 45 in tubolare di acciaio zincato
piano di appoggio in legno multistrato dim. cm.150x30
Plyometric bench adjustable heights (from 30 to 45 cm.) in galvanized steel wooden board dim. 150x30 cm.

pg.10

Art. 1PP40/2PP40/3PP40 1PP50/2PP50/3PP50
Panca per pliometria in acciaio verniciato, lunghezze disponibili: cm. 100 / cm. 200 / cm. 300 larghezza cm. 35 altezze disponibili: cm. 40 / cm. 50
piano di appoggio in legno rivestito in gomma antiscivolo
Plyometric bench in painted steel, available length 100 / 200 / 300 cm. width 35 cm. available height 40 / 50 cm. board made of wood with anti-skid rubber cover



pg.11



Art. AHF-140
Parallelepipedo per pliometria in legno cm. 76x61x51 utilizzabile a 3 diverse altezze
Wooden plyometric box 76x61x51 cm. 3 different heights

New!

Art. VCU60/VCU70/VCU80
Cubo per pliometria in legno verniciato al naturale con gomma antiscivolo sui piani di appoggio lato cm.60/70/80
Wooden plyometric cube with anti-skid rubber - 60/70/80 cm. side



Art. PAV2 Set 3 plinti soft a basi rettangolari, sovrapponibili - 3 altezze ottenibili: cm. 30, 60, 90 in gommapiuma rivestita con PVC ignifugo Cl. 1
Set of 3 rectangular base soft steps - by placing them one upon the other you can get 3 different heights: 30, 60, 90 cm.

TRAMPOLINI - Trampolines



Art. 166
Trampolino elastico Ø cm. 97
Trampoline Ø 97 cm.



Art. TF-03
Trampolino elastico Ø cm. 122
pieghevole - 40 molle
Trampoline Ø 122 cm.
foldable - 40 springs

pg.8

Art. V1709
Trampolino elastico
ad altezza fissa
dim. cm.125x125
Trampoline 125x125 cm.
reinforced



Art. S01154
Trampolino elastico
ad inclinazione
regolabile
completo di protezioni
dim. cm. 125x125
Trampoline
size 125 x 125 cm.
adjustable inclination
with soft perimetric
protection

Art. TRO-9
Trampolino da esterno Ø cm. 305
con rete di protezione perimetrale
Outdoor trampoline cm. 305 diameter
with perimetric protection net



SCALE - CERCHI - CORDE - Speed Ladders - Hoops - Jumping Ropes



Art. SL4

Scala lunghezza m. 4 con 10 pioli rotondi per esercizi di coordinazione motoria (compresa sacca per il trasporto)

Speed ladder length 4 meters with 10 tubular rungs for quick step and coordination exercises, bag included

pg.10

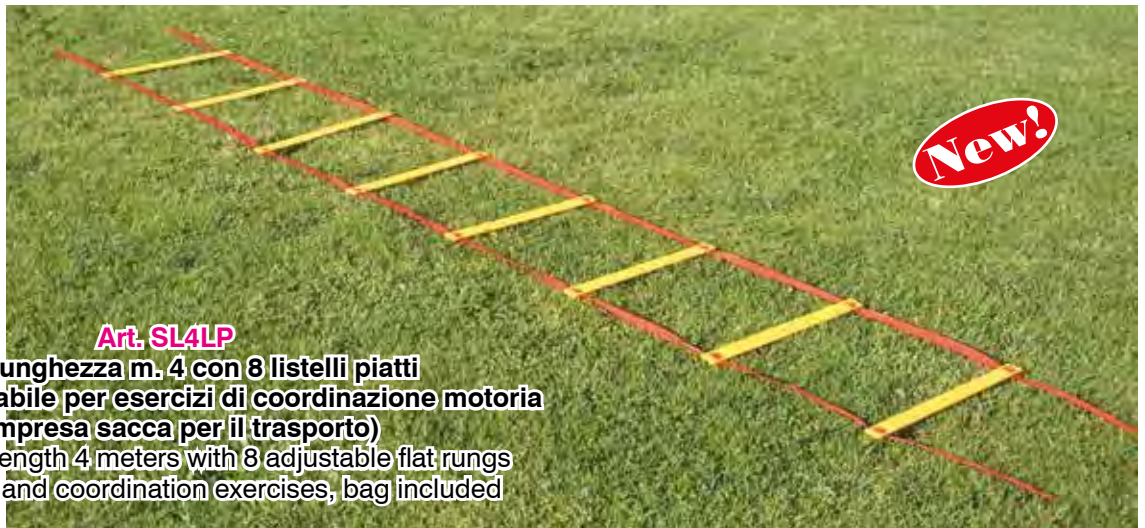

Art. SL4LP

Scala lunghezza m. 4 con 8 listelli piatti a distanza regolabile per esercizi di coordinazione motoria (compresa sacca per il trasporto)

Speed ladder length 4 meters with 8 adjustable flat rungs for quick step and coordination exercises, bag included



Art. SL6

Scala lunghezza m. 6 con 12 listelli piatti a distanza regolabile (compresa sacca per il trasporto)

Speed ladder length 6 meters with 12 adjustable flat rungs, bag included

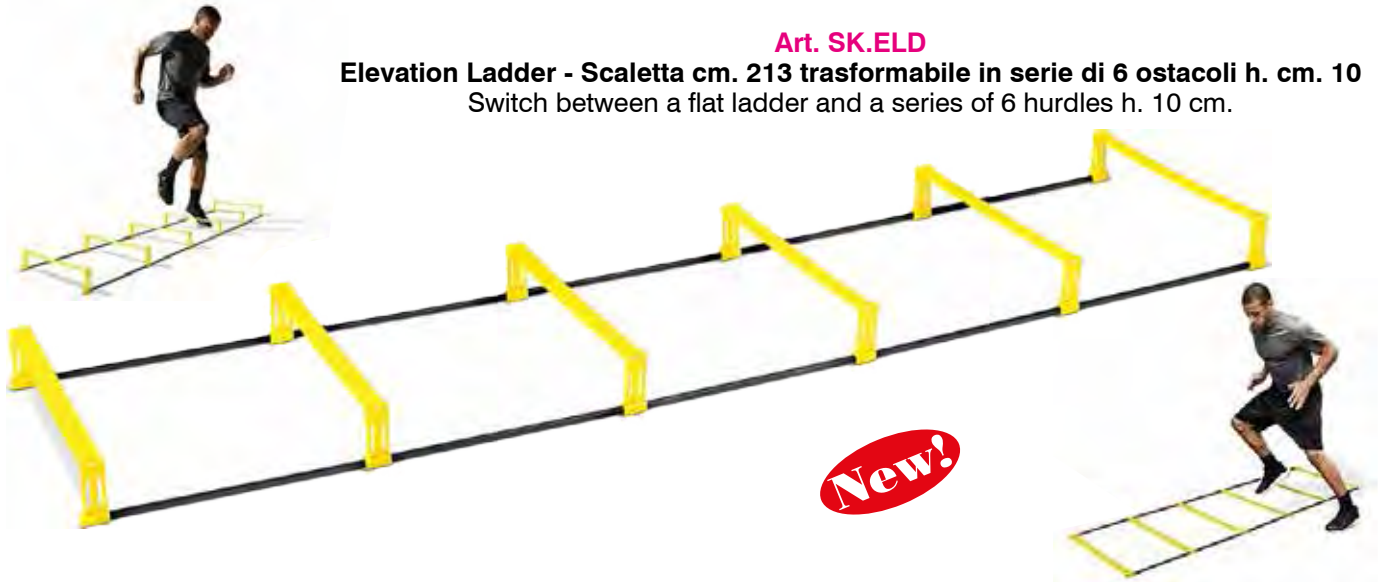

Art. SK.ELD

Elevation Ladder - Scaletta cm. 213 trasformabile in serie di 6 ostacoli h. cm. 10
Switch between a flat ladder and a series of 6 hurdles h. 10 cm.

pg.10



Art. 708241

Scala in plastica flessibile lunghezza m.4 con 10 pioli spessore cm.1,5
dimensione quadri cm.40x40 pieghevole con rimessaggio
Flexible speed ladder length 4 meters in plastic pipes 1,5
thick - foldable with holder



Art. 701411

Minibirillo
concavo altezza cm. 9
per sollevamento
scala Art. 708241

Cone 9 cm. height carved on
top for Art. 708241
underneath support



Art. K4111

Kit scala Art. 708241
+ 20 Minibirilli Art. 701411

Kit Art. 708241 + 20 x Art. 701411



Art. 995215

Cor Web da 36 quadri cm. 35x35
dimensioni totali cm. 465x210
composto da 13 stecche gialle semirigide
e 4 strisce in cinghia rossa

Speed ladder 36 squares 35x35 cm. each
overall dimensions 465x210 cm.

Art. 995216

Borsa per Cor Web in nylon con cordoncino e
stopper per chiusura, con maniglia per il trasporto
Bag for Cor Web 36 squares

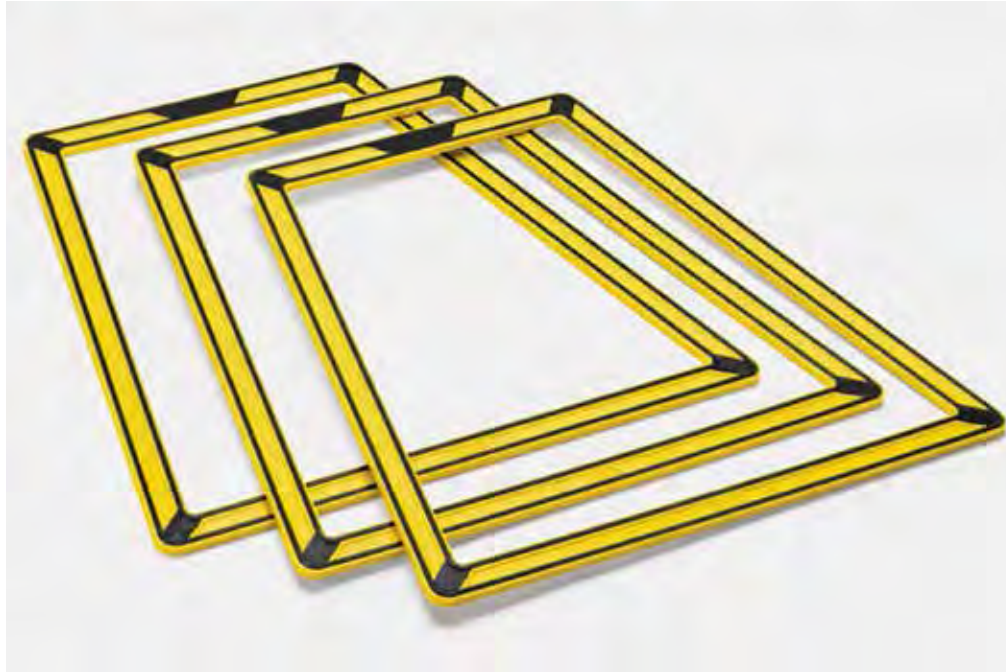

Esempi di combinazioni possibili
A few examples

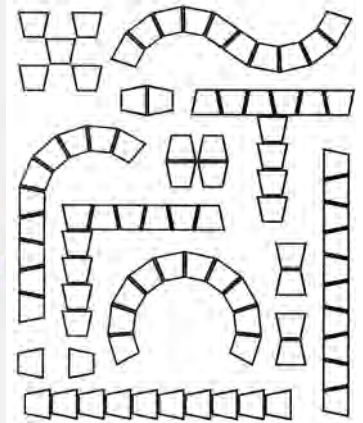

pg.10

Art. SK.ATP
Agility Trainer Pro - set 10 TRAPEZI componibili
per allenamento agilità e coordinazione multidirezionale
e per il miglioramento della velocità e dei tempi di reazione
Agility Trainer Pro - customizable footwork and agility trainer
designed for curvilinear and alternative training patterns,
cuts your reaction time while adding speed in all directions
Set of 10 trapezoids with a carry handle

New!



Con questo nuovo strumento di allenamento creativo si possono incrementare le doti di rapidità, agilità e potenza nei cambi di direzione e nelle traiettorie curvilinee che gli atleti sono chiamati ad effettuare durante la gara. Questi speciali trapezi sono molto stabili su ogni tipo di terreno, permettendo così un esercizio senza interruzioni



Sports don't happen in a straight line, now neither does your training. The Agility Trainer Pro lets you recreate the curvilinear and broken patterns that take place in sports, helping you set up your cuts, turns and changes of direction. It lets you add the multi-directional quickness and precise footwork that can quickly change the game. The Agility Trainer Pro won't slip, slide or otherwise interrupt your training sessions

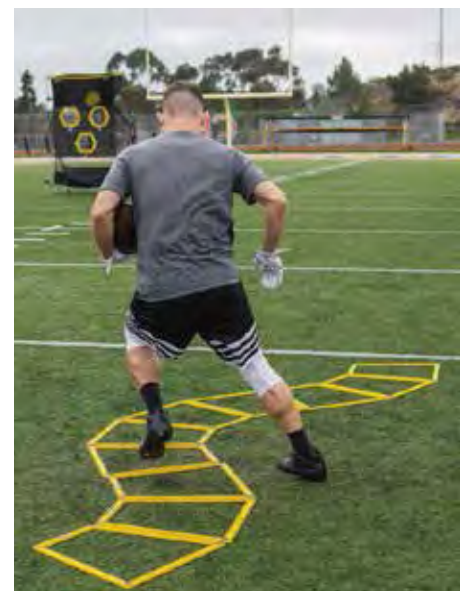

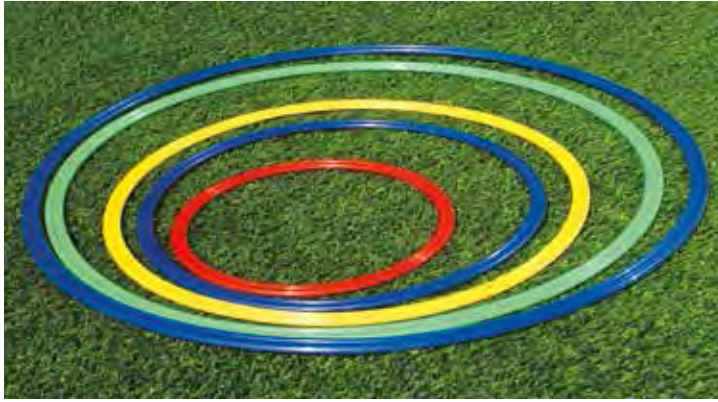

Art. CNP30 / CNP40 / CNP50 / P00181 / P00191 / P00201
Cerchio in nylon piatto Ø cm. 30 / 40 / 50 / 60 / 70 / 80
 Flat Nylon Hoop Ø 30 / 40 / 50 / 60 / 70 / 80 cm.



Art. P00182 / P00192 / P00202 / P00212
Cerchio in PVC tubolare
 Ø cm. 60 / 70 / 80 / 90
 Tubular PVC hoop
 Ø 60 / 70 / 80 / 90 cm.



**Art. S00402/S00405/
 S00406/E21**
**Bastone in legno o
 PVC cm. 80 - 100 - 120**
 Wooden and PVC Stick
 80 - 100 - 120 cm.

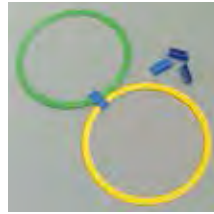

Art. OCC11
**Connettore per
 cerchi piatti**
 Flat Hoop Connector



Art. S00472
**Mensola porta
 cerchi a parete
 in acciaio
 verniciato**
 Hoop wall Holder
 in painted steel



Art. S00414
**Mensola porta bastoni a parete
 in acciaio verniciato**
 Stick wall Holder in painted steel

 pg.9



Art. 043
**Corda per salto in canapa con manici
 in legno ed ingrossamento centrale**
 Hemp Skipping Rope with hardwood
 handles, thicker in the middle section



Art. 043P
**Corda per salto in nylon
 con manici in legno**
 Nylon Skipping Rope with
 hardwood handles



Art. AHF-017
**Corda per salto in PVC
 con manici soft touch
 e cuscinetti a sfera**
 PVC Skipping Rope
 with soft handles
 and ball bearings



Art. CS1
**Corda per salto in canapa con ingrossamento
 centrale (senza manici)**
 Hemp Skipping Rope thicker in the middle without handles



Art. 043L Corda per
 salto in pelle
 Leather Skipping Rope
 with hardwood handles



Art. STAR

Starkick completo di cintura e corda elastica per allenamento ai palleggi ed al tocco di palla (pallone escluso)

Starkick with belt and elastic rope for ball kick and control training (ball not included)

pg.10



Art. OTK

Training Kicker con corda non elastica per allenamento ai palleggi ed al tocco di palla (pallone escluso)

Training Kicker with non elastic rope for ball kick and control training (ball not included)



Art. TIM-SP

Supporto per Tackle improver
Holder for Tackle improver

Art. TIM

Tackle improver per allenamento al contrasto
For tackle training

Uno strumento innovativo per migliorare la tecnica di esecuzione e la potenza del contrasto.

Il Tacke Improver indirizza il piede d'appoggio verso la posizione più idonea per esprimere la maggiore potenza d'impatto.

Potenzia inoltre tutte le catene muscolari che intervengono nel contrasto, ma senza causare traumi, grazie ad una speciale molla collegata al pistone che sorregge il pallone.

Very useful training device for strengthening all muscles involved in tackling.

Absolutely safe, thanks to a spring and piston system that avoids injuries.



pg.10



Art. CVCO

Cavigliera Coordinativa con contrappeso, migliora l'equilibrio e l'indipendenza psicomotoria delle gambe, ed in particolare ammorbidisce la gamba dominante migliorandone la sensibilità del piede

Rotating ankle, with weight, to improve equilibrium and leg independence: in particular it softens the dominant leg improving sensibility of the non dominant foot



pg.10

ALLENAMENTO SOTTO CARICO E FUNZIONALE - Training with weights



Art. SLD



Art. ASN
Cintura in pelle sintetica con velcro completa di corda, catena e moschettoni di ricambio per slitta Art. SLD
Synthetic leather belt, rope and chains spare for Art. SLD

Art. SLD Slitta per il miglioramento della capacità di accelerazione tramite il traino a carico variabile completa di cintura in pelle sintetica con velcro, corda e moschettoni (dischi in ghisa non inclusi)
Sledge (weights not included) improving acceleration with synthetic leather belt, rope and chains

pg.9

Art. CBV
Cintura in pelle sintetica con velcro di ricambio per Art. SLD
Synthetic leather belt w/velcro spare for Art. SLD



In dotazione 3 sacchi di capacità Kg. 4,5 da riempire con sabbia
Includes 3 x 4,5 Kg. sacs to be filled with sand

Art. SK.SPSC
Speed Sac - sacca di training con pesi unitaria di cintura e moschettone utilizzabile anche indoor o su superfici sintetiche
Improves overall speed and explosiveness
Boosts acceleration and stride length
Adjustable weight options for variable resistance
portable and versatile to be used anywhere

pg.10



New!

pg.9



Art. 045
Giubbino caricabile con pesi fino a Kg.10 (pesi inclusi)
Jacket Weighted up to 10 Kg. (weights included)

pg.10



Art. PCH
Paracadute per potenziamento della corsa
Parachute to improve the power of your run



pg.9

Art. 991310/991311/991312
Shoulder Bag con 3 maniglie
pesi disponibili Kg. 10/15/20
Shoulder Bag with 3 handles
weights available 10/15/20 Kg.



Art. PBG-5/PBG-10/PBG-15/PBG-20/PBG-25
BORSA ZAVORRATA
con 6 impugnature
pesi disponibili Kg.5-10-15-20-25
HEAVY BAG with 6 handles
weights available 5-10-15-20-25 Kg.

pg.9

Art. BGZ
BORSA GONFIABILE zavorrata con acqua (a peso variabile)
cm. 85 con 4 maniglie - consente nuovi esercizi di forza
coordinata grazie alla massa oscillante interna
INFLATABLE BAG with water inside, length cm. 85 with 4 handles
allows new exercises for muscle strength thanks to the dynamic
weight inside



Art. V5083
Pedana di salto in tubo in acciaio dim. cm. 100x100
con elastico rigido a tensionamento uniforme
e dinamometro, cintura e moschettoni
(dischi in ghisa non inclusi)
Jump Platform in painted steel dim. 100x100 cm.
with elastic rope and dynamometer, belt and snap-hooks
(weights not included)

pg.10



Art. BR-3812 / BR-5015
Fune da allenamento
Battle Rope
ø mm 38 lunghezza mt. 12
oppure
ø mm 50 lunghezza mt. 15
Battle Rope
12 meters - 38 mm. thick or
15 meters - 50 mm. thick

pg.9



In poliestere intrecciato con impugnature rivestite in gomma termoretraibile
ideale per il potenziamento dei muscoli di spalle e avambracci,
ottimo allenamento cardiorespiratorio
Polyester encased rope with shrink-wrap handles, perfect for strengthening shoulders
and forearm muscles, excellent cardio-respiratory workout

FUNCTIONAL TRAINING



pg.9

FT.IST

Functional Training
Attrezzo polifunzionale
per il potenziamento della catena estensoria
e flessoria degli arti superiori e inferiori
Functional training multi-purpose
belt for the enhancement
of the extension and flexion muscular
chains of the upper
and lower limbs

New!



FST-DBL

Functional Training Double Pro
Attrezzo professionale per allenamento
in sospensione con maniglie svincolate
utilizzabili separatamente
Functional training with free handles to be used also
separately - steel snap hooks and rings



MTLTX

Lacci di Trazione
Traction Laces

pg.9

PLTRZ
Prolunga
per Lacci
di Trazione
Extension for
Traction Laces



Attrezzo polifunzionale per il potenziamento della catena estensoria e flessoria degli arti superiori e inferiori
Multi-purpose belt for the enhancement of the extension and flexion muscular chains of the upper and lower limbs



Art. DTL15

Lacci di Trazione
dinamici
con carrucola
Dynamic functional
training with pulley

BANDE ELASTICHE - BOA - Elastic Bands

pg.11

pg.12



Art. IFBG
Fitness band colore giallo
yellow
cm. 175x15

Art. IFBR
Fitness band colore rosso
red
cm. 175x15

Art. IFBB
Fitness band colore blu
blue
cm. 175x15

Art. IFBN
Fitness band colore nero
black
cm. 175x15



Art. 991707/ 991708/ 991709
SET 10 ELASTICI AD ANELLO
colore giallo (morbido) - rosso (medio)
verde (resistente) Ø cm. 27,50
Elastic Rings yellow (soft) - red (medium)
green (hard) 27,5 cm. Ø



Art. AHF-141
Coppia maniglie per fitness band
Pair of handles for fitness band



Art. AHF-128/AHF-129/AHF-130/AHF-131/AHF-132
Elastico ad anello POWER BAND
Ø mm. 2080x4,5 spessore
rosso h. mm. 13 - nero h. mm. 22
viola h. mm. 29 - verde h. mm. 45
blu h. mm. 64
Power Band elastic Ø mm.2080x4,5 thick
red 13 mm. height - black 22 mm. height
violet 29 mm. height - green 45 mm. height
blue 64 mm. height



Art. 991710/ ... /991742
Elastico tubing con e senza maniglie
colore rosso, giallo, viola, nero
Elastic with and without handles
red, yellow, violet, black color



Art. RLEF
Rotolo lattice fucsia per esercizi muscolari,
larghezza cm. 15,
lunghezza m. 25
spessore 0,3 mm.
Elastic fuchsia Band
for muscle exercises,
15 cm. wide,
25 meter long,
0,3 mm. thick



Art. RLEG
Rotolo lattice giallo per esercizi muscolari,
larghezza cm. 15,
lunghezza m. 25
spessore 0,5 mm.
Elastic yellow Band
for muscle exercises,
15 cm. wide,
25 meter long,
0,5 mm. thick

Art. AHF-068
Set 3 elastici tubing con maniglie
tre differenti livelli di resistenza
impugnature ergonomiche soft touch
per esercizi arti superiori e inferiori
completo di borsa in microrete
Set 3 elastics with handles
3-level resistance - soft touch handles,
bag included - tones and strengthens
arms, legs, gluteus, abdominals,
shoulders and chest muscles



pg.11



Art. AKHF

Kit Home Fitness comprendente rinforza spalle, sistema carrucolare, bastone estensibile, Antonelast uomo, Antonelast donna
 Kit includes shoulder strengthener, extensible stick, Antonelast for man and Antonelast for woman

Art. ARS.3 Banda Elastica rinforza spalla - può essere usata in ogni luogo che abbia un appiglio per la chiusura a velcro (anche in casa o in albergo) grazie alla presenza di uno spessore che a porta chiusa non fa scivolare l'attrezzo e non danneggia la porta
 Elastic Band for shoulder injury training exercises

pg.12



Art. 995238V/995239V/995240V

Barra in alluminio con bande elastiche gialle (soft)/blu (medium)/verdi (hard) impugnature in neoprene e maniglie morbide
 Aluminium Bar with yellow (soft)/blue (medium)/green (hard) elastic bands, neoprene soft handles

Art. PTI.SPS

Slide Pads - paio di slide pads utilizzati per esercizi di scivolamento di mani e piedi volti al miglioramento della flessibilità e della forza muscolare
 Set of 2 pcs. - simulates many slide board exercises - conditioning tool to improve flexibility, shaping and core strength



New!

pg.11



New!



Art. PTI.STR

Slide Trainer - lunghezza cm.140 con 2 scarpette con velcro per lo scivolamento
 Utile strumento per sviluppare la forza laterale, la potenza, la resistenza, l'equilibrio, l'agilità, la velocità e la flessibilità
 Slide Trainer length 140 cm. with 2 gliding shoes great for developing lateral strength, power, endurance, balance, agility, speed and flexibility

Art. 016824

ELASTICO BOA in gomma para mm. 7x18 rivestito con guaina di sicurezza lunghezza mt. 3 con un moschettone a ciascuna estremità, resistenza Kg. 30

Rubber BOA 7x18 mm. with safety sheath 3 meter length, resistance 30 Kg.

pg.11



Art. 016824
ELASTICO BOA

Art. 016826
CINTURA Senior



Art. 016827
Paio polsini per elastico BOA
Pair of wristbands for BOA exercises

Si suggerisce l'utilizzo dell'elastico BOA con una cintura o con un altro tra gli accessori disponibili

Utilization of rubber Boa is suggested with a belt or with another available accessory



Art. 016828
Paio cavigliere per elastico BOA
Pair of anklebands for BOA exercises

Art. 016825

CINTURA Junior da agganciare a elastico BOA diametro max cm.105

Junior Belt for BOA traction - max diameter 105 cm.

Art. 016826

CINTURA Senior da agganciare a elastico BOA diametro max cm.140

Senior Belt for BOA traction - max diameter 140 cm.

pg.11



Art. 016829
Pettorina per elastico BOA
Shoulder belt for BOA exercises



Art. C3005
Staffa per ancoraggio elastico BOA a parete
BOA wall anchor bracket



Anello scorrevole
"free-floating" ring



pg.11

New!

Art. SK.R360

Recoil 360 - elastico con cintura ad anello scorrevole utilizzabile in autonomia o con l'aiuto del preparatore

Maximizes power, speed and vertical jump

Engineered with a "free-floating" ring for 360 degrees of movement

Designed for solo use or for training with a partner

DYNAMIC RESISTANCE / ASSISTANCE TRAINER



Art. SK.ACTR

Acceleration Trainer

per l'allenamento della velocità in ogni direzione, dell'accelerazione e della velocità massima

Da utilizzare con l'aiuto del preparatore

Trains speed in every direction
Builds speed and power from the start, during acceleration and at the top-end
Designed for training with a partner



pg.11

DYNAMIC OVERLOAD AND RELEASE SYSTEM



Anello scorrevole "free-floating" ring

New!



Art. SK.LRP

Lateral Resistor Pro

Attrezzo per migliorare la velocità del primo passo e la rapidità laterale con elastici tubolari intercambiabili a diversa resistenza

Develops first-step quickness and lateral speed
Patented Slide-Lock system for quick, safe switching of resistance cables

STRENGTH AND SPEED TRAINER

New!



pg.11

VERTICAL JUMP TRAINER



New!



Art. SK.HPZ

Hopz 2.0

Attrezzo per migliorare la forza e la potenza dei muscoli impegnati nell'elevazione, con elastici tubolari intercambiabili a diversa resistenza

Builds explosive leg power and strengthens jumping muscles
You can move resistance cables on belt to target specific muscles and change resistance cable quickly





Art. AE
Banda elastica Antonelast per esercizi di stretching e potenziamento muscolare
 Elastic band for body muscle exercises



Con velcro cucito su entrambe le estremità
 with velcro seamed at both sides



Art. RA
Rinforza abduttori
 Elastic band for abductor muscles

Con velcro cucito su entrambe le estremità
 with velcro seamed at both sides



pg.11



Art. OSI
Over Speed Improver - Tramite questa cintura elastica l'atleta più veloce trascina il più lento, incrementando contemporaneamente la velocità di entrambi
 By this elastic belt the quicker player pulls the slower player, increasing both athletes' speed



Con velcro cucito su entrambe le estremità
 with velcro seamed at both sides



Art. PSR
Power Speed Resistor per potenziamento della corsa esercizio in coppia (nylon non elastico)
 To improve explosive force - two people involved (non elastic band)



Art. EPW
Elastic Power 2 fasce con cintura in pelle incrementa la forza esplosiva potenziando la muscolatura delle gambe e del dorso
 2 Bands with leather belt for explosive strength improvement, for leg and back muscle training



Art. SRE
Speed Reaction
 Allenamento dei riflessi e della reattività
 (l'elastico non si sgancia se il difensore perde contatto dall'attaccante)
 Reflex and reactivity training device (the belt does not separate if the defender loses contact)

Cintura elastica
 Elastic belt



Cintura non elastica
 Non elastic belt

Art. EB
Evasion Belt - Allenamento dei riflessi e della reattività ideale per marcature a uomo
 (la cintura si sgancia se il difensore perde contatto dall'attaccante)
 Reflex and reactivity training device, for man to man coverage (the belt separates if the defender loses contact)



Art. RIM
Reaction Improver
 per l'allenamento della reazione allo stimolo visivo in percorsi ad ostacoli, ideale per marcature a uomo
 (l'elastico si stacca se si perde contatto)
 Elastic Belt for visual reflex training in drill sections, for man to man coverage (the elastic separates if following athlete loses contact)



pg.11



Art. KAP Kit allenamento portiere Goal-Keeper training Kit, **composto da: 10 Antonelast, 1 Cintura, 1 Rinforza abduttori, 4 Anelli fissa bande** made of 10 Antonelast, 1 Belt, 1 Abductor muscle band, 4 connecting rings - **per il miglioramento della forza esplosiva** to improve explosive muscular strength and goal keeper's jumps and dives



Art. KAT Kit allenamento tattico, composto da : **7 bande elastiche di metri 10 cadauna**
 Tactical training Kit, made of 7 Elastic bands 10 meter long each



Art. SC010

OFFERTA KIT TECNICO SCUOLA CALCIO

pg.10

Kit così composto: n.15 Paletti slalom Art.007

n. 15 basi ad imbuto Art.018 - n. 1 kit delimitatori Art.016 - n. 6 ostacoli over cm.12 Art.80.12
n. 2 ostacoli over cm.20 Art.80.20 - n. 2 ostacoli over cm.30 Art. 80.30 - n. 2 ostacoli over cm.40 Art.80.40
n. 12 corde salto Art.043P - n. 1 Scala a pioli Art. SL4 - n. 12 Maxidelimitatori h.cm.28 Art.019.1
n. 12 cerchi piatti diam.cm.50 Art.CNP50 - n. 1 Tavoletta propriocettiva in ABS Art.168PC

SOCCER SCHOOL KIT SPECIAL OFFER

15 x Art.007 + 15 x Art.018 + 1 x Art.016 + 6 x Art.80.12 + 2 x Art.80.20 + 2 x Art.80.30 + 2 x Art.80.40
+ 12 x Art.043P + 1 x Art.SL4 + 12(pieces) x Art.019.1 + 12 x Art.CNP50 + 1 x Art.168PC



FITNESS BODY-BUILDING

Art. S01108

Art. S01106



Art. S01106
Spalliera Svedese
a 1 campata
dim. 90x250 cm.
in faggio evaporato
Swedish Wall Bar 1 span

pg.14

Art. S01108
Spalliera Svedese
a 2 campate
dim. 180x250 cm.
in faggio evaporato
Swedish Wall Bar 2 spans



Art. S00908
Panca per addominali imbottita
agganciabile a spalliera
Abdominal bench to be fixed to
Swedish Wall Bar



Art. UNG05 / UNG1 / UNG2 / UNG3 / UNG4 / UNG5
Coppia Manubri in ghisa rivestiti
Kg. 0,5-1-2-3-4-5 cadauno
Pair of Dumb Bells from 0,5 to 5 Kg. each one

pg.12



Art. F301
Porta manubri in ferro
Dumb Bell Rack



Art. 17222
Cintura Body Building h. cm. 10 - misure da S a XL
Body Building Leather Belt h. 10 cm.
sizes from S to XL



Art. AS196
Coppia fermadischi a vite
Pair of plate holders with thread

pg.12

Art. US176
Coppia fermadischi a T
Pair of T-shaped plate holders



***Fermadischi a vite inclusi**
Plate holders with thread included

***Art. US304/US305**
Bilanciere Weight bar
cm. 150 / cm. 180

***Art. US301 Manubrio a dischi inseribili cm. 35**
Hand bar length 35 cm.



***Art. US303**
Bilanciere sagomato
Bar cm. 120



Art. UN640
Dischi in ghisa foro mm.26
Kg. 0,5 - 1 - 2 - 5 - 10
15 - 20 cadauno
Cast Iron Weight Plates
hole 26 mm.



Art. DGG
Dischi in ghisa foro mm.26 rivestiti in gomma
Kg. 0,5 - 1 - 2 - 5 - 10 - 15 - 20 cadauno
Cast Iron Weight Plates hole 26 mm. covered with rubber



Art. US287
Coppia fermadischi a molla
Pair of spring plate holders

Art. F302
Porta dischi in ferro
Weight Plates Rack



Art. 17203
Paio guanti Lycra
misure da XS a XL
vari colori
Gym Gloves Lycra



pg.12

Art. 30907
Paio guanti Premium Pro
misure da S a XL
vari colori
Gym Gloves Premium Pro



Art. 13382 / 13383 / 13384 / 30937
Paio Cavigliere Kg. 0,5 - 1 - 1,5 - 2 cadauna
Pair of Ankle Weights 0,5 - 1 - 1,5 - 2 Kg. each one



pg.13

Art. AHF-093
Paio Cavigliere Kg. 2,5 cadauna con pesi estraibili
Pair of Ankle Weights 2,5 Kg. each removable weights





Art. AHF-026
Coppia maniglie per flessioni
Push-up handles



Art. AHF-070
Estensore con elastici
Chest-Expander



Art. AHF-161
Coppia Parallettes h. cm. 75
Pair of Parallettes 75 cm. height

pg.13



Art. AHF-074
Coppia sostegni ruotabili per flessioni
Turnable Push-up handles

Art. AHF-021
Coppia Tenaglie stringimano con impugnatura soft touch
Pincers for hand strengthening



Art. AHF-047
Ruota doppia per addominali
Double Wheel for abdominal muscles



Art. AHF-157
Coppia manubri con ruote per addominali
Pair of dumb bells with wheels for abdominal muscles



Art. AHF-063
Contapassi (ad esaurimento)
Step Counter (until available)

pg.14



Art. AHF-064
Contapassi multifunzione
Multi-function Step Counter



Art. BTM-R
Barra per trazioni
con fissaggio a parete
o soffitto
Exercise Bar

pg.13



Art. STX-1
Ministepper
Tensione a pistoni idraulici.
Computer a 3 funzioni: tempo,
numero steppate, pulsazioni.
Peso massimo utilizzatore 100 kg.
Ministepper with hydraulic rams



Art. BTE
Barra Entroporta
Door Bar

Art. OCST
Gradino step a 2 altezze (10-15 cm.)
con antiscivolo dim. cm. 68x30
Step 2 heights
(10-15 cm.) with anti-skid dim. 68x30 cm.



pg.14

Art. WBX-70
Power Tower
Attrezzo multifunzione ideato per l'allenamento intensivo
di tutto il corpo senza l'utilizzo dei pesi
Tubolare a sezione quadrata da 5 cm.
Peso massimo utilizzatore 120 Kg.
Multi purpose tool for intensive
body training without weights



Art. AHF-003
Gradino step regolabile a 3 altezze
(cm. 15-20-25)
superficie antiscivolo dim. cm. 89x39
Step adjustable at 3 different heights
(maximum height 25 cm.)
with anti-skid surface dim. 89x39 cm.



Art. E680
Bracciale porta oggetti
in neoprene cm. 14,5x8x2
Neoprene arm wallet

pg.13



Art. AHF-092
Fascia da braccio
porta smartphone
Arm smartphone holder



Art. WBK-400
Panca multifunzione
telaio in acciaio,
schienale regolabile
portata massima kg. 120
Weight lifting Bench



Art. WBK-500
Panca pesi con supporti
bilanciere, telaio in acciaio,
schienale regolabile
peso max utilizzatore kg. 100
Weight lifting Bench
with bar holders

ATTENZIONE: questi prodotti sono concepiti esclusivamente per uso home fitness, perciò la garanzia non copre il loro utilizzo presso palestre o centri sportivi



Art. WBX-80
Panca piana/90° Power Bench
rinforzata (abbinabile con Power Rack)
Power Bench

pg.14



Art. GYM1000
Stazione Multifunzione
dotata di torre per dorsali, pressa per
pettorali, attrezzo per le gambe, vogatore,
cuscino per bicipiti - carico massimo 60 Kg.
15 esercizi praticabili
Peso massimo utilizzatore 120 Kg.
Multi purpose machine



Art. WBX-50
Power Rack
Supporti per bilanciere
Altezza e larghezza
regolabili
Dotato di 2 rimessaggi
per dischi
Peso massimo
caricabile 200 Kg.
Supports for weight bar

ATTENZIONE: questi prodotti sono concepiti esclusivamente per uso home fitness, perciò la garanzia non copre il loro utilizzo presso palestre o centri sportivi

Art. 729761
Panca a inversione chiudibile
Schienale rigido imbottito
Regolabile secondo l'altezza dell'utilizzatore: minima cm. 147, massima cm. 198
Peso max utilizzatore 100 Kg.
Inversion Bench



Art. WBK-100
Panca per addominali chiudibile
portata kg. 100
Bench for abdominal muscle training



pg.14



Art. AB-CNH
AB Crunch Master
richiudibile



Art. WBK-600
Panca multifunzione a cavi elastici
richiudibile
Foldable multi-function bench



Art. GWM13
Pedaliera manuale utilizzabile da seduti per gli arti inferiori e appoggiata sul tavolo per gli arti superiori
Peso 5 Kg. - con computer
Intensità sforzo regolabile
Cycling device for arm and leg exercises



pg.13

Art. GWE13
Pedaliera elettrica per la ginnastica passiva degli arti inferiori e superiori
Velocità regolabile con telecomando
Peso 6 Kg. - con computer
Cycling electric device for arm and leg exercises





Art. BFK-300

Bici da camera con freno magnetico
Regolazione dell'intensità manuale a 8 posizioni
Volano da 4 Kg. - Computer a 6 funzioni: tempo, velocità, distanza, calorie, scan, pulsazioni con sensori Hand Pulse
Peso massimo utilizzatore 100 Kg. - Peso dell'attrezzo 20 Kg.
Cyclette Magnetic with 6 function computer

Art. BRX-60

Bici da camera con freno magnetico
Regolazione dell'intensità manuale a 8 posizioni
Volano da 7 Kg. - Computer a 6 funzioni: tempo, velocità, distanza, calorie, odometro, pulsazioni con sensori Hand Pulse
Peso massimo utilizzatore 110 Kg.
Peso dell'attrezzo 24 Kg.
Cyclette Magnetic with 6 function computer

New!



pg.13

ATTENZIONE: questi prodotti sono concepiti esclusivamente per uso home fitness, perciò la garanzia non copre il loro utilizzo presso palestre o centri sportivi



Art. BRX-RC

Bici da camera con freno magnetico e sedile con schienale
Regolazione dell'intensità manuale a 8 posizioni
Volano da 7 kg
Computer a 7 funzioni: tempo, velocità, distanza, calorie, pulsazioni con sensori Hand Pulse, odometro, scan
Peso massimo utilizzatore 110 Kg.
Peso dell'attrezzo 28,5 Kg.
Cyclette Magnetic with 7 function computer, seat adjusting system

Art. SRX60

Spinning Bike
con volano da Kg. 20
Trasmissione a cinghia con pignone fisso
Sistema di frenata a pattini con feltri
Computer con LCD (velocità, tempo, distanza, calorie, odometro, scan, hand pulse)
Sella regolabile in orizzontale ed in altezza
Manubrio regolabile in altezza con appoggio per l'avambraccio
Portaborraccia
Peso massimo utilizzatore 125 Kg.
Peso dell'attrezzo 41 Kg.
Cyclette Magnetic with seat and handle-bar adjusting systems



Art. 18220
Coprisella spinning
Seat cover
for spinning bike

ATTENZIONE: questi prodotti sono concepiti esclusivamente per uso home fitness, perciò la garanzia non copre il loro utilizzo presso palestre o centri sportivi



Art. TFK-MAG

TAPIS ROULANT MAGNETICO TFK-SLIM-MAG

piano di corsa cm.38x102
sistema di frenaggio magnetico su 8 posizioni
doppio volano Kg.6 - peso massimo
utilizzatore Kg.100 - display LCD indicante velocità,
frequenza cardiaca, distanza, tempo,
consumo calorico, scan, rilevazione cardio Hand Pulse
Tapis roulant magnetic with no engine,
with multi function computer

pg.13



Art. TFK-250E

TAPIS ROULANT TFK-250 EVO

motore 1,75/2,75 HP DC - velocità 0,8-14 Km/h
inclinazione manuale - piano di corsa cm. 42x123
peso massimo utilizzatore 100 Kg.
1 programma libero, 12 preimpostati, display LCD
indicante velocità, frequenza cardiaca, distanza,
tempo, consumo calorico, programma in esecuzione
Tapis roulant with 1,75/2,75 hp engine and
multi program computer



Art. TFK-455

TAPIS ROULANT TFK-455 SLIM

motore 2,00/3,00 HP DC - velocità 0,8-16 Km/h
inclinazione elettrica - piano di corsa cm.42,5x127
peso massimo utilizzatore 110 Kg.
1 programma libero, 12 preimpostati, display LCD
indicante velocità, inclinazione, frequenza cardiaca
tramite Hand Pulse, distanza, tempo,
consumo calorico, programma in esecuzione
Tapis roulant with 2/3 hp engine and multi program computer

pg.14

Art. TRXRC
Vogatore Rower Compact - display LCD indicante
numero vogate, calorie, tempo, scan
regolazione sforzo su 12 livelli
peso max utilizzatore 110 Kg.
Rower machine with computer



CASACCHE - Mesh Shirts



Art. 088-A

Casacca traforata fluo taglia adulto

Fluo pierced training bib adult size - colors as in the picture



Art. 088-B

Casacca traforata fluo per bambini fino a 9 anni

Fluo pierced training bib small size - colors as in the picture



pg.16

Art. 088-D

Casacca traforata double-face fluo taglia adulto colori rosso/blu - giallo/arancio

Fluo pierced training bib double-face adult size
colors red/blue - yellow/orange



Art. GIL01

Gilet steward

Colori giallo - arancio
Colors yellow - orange

PANTALONCINI - CALZE - GUANTI - T-SHIRT - GIACCHE PIOGGIA Shorts - Socks - Gloves - T-shirt - Rain jackets



**** VERIFICARE MINIMI D'ORDINE SUL LISTINO PREZZI ****
Minimum required quantity shown on price list

Art. MF01
Pantaloncino da allenamento
100% poliestere
taglie dalla 3XS alla XXL
Colori: royal, bianco, bordeaux,
verde, navy, rosso, nero
(minimo ordine 5 pz.
per taglia e per colore)
Shorts in polyester
size from 3XS to XXL
Colors: white, red, royal,
blue, black, brown, green
(minimum order 5 pieces
per size and color)



Art. IS005
Paio calze calcio con piede
Taglie
Bimbo: 29-34
Ragazzo: 35-40
Uomo: 41-46
Colori: royal, giallo limone, bianco,
bordeaux, navy, rosso, nero,
Pair of soccer socks sizes: Kid, JR, SR
Colors: white, red, royal, blue, black, brown,
lemon yellow



pg.16

Art. TOGA
Guanti in acrilico elasticizzati
con antiscivolo - colore nero
misura junior e senior
Black elastic acrylic Gloves
with anti-skid
size junior and senior



pg.17

Art. TOS1
Scaldacollo in pile
taglia unica regolabile
Neck warmer in pile
one size fits all



Art. TOBA
Berretto in acrilico
nero, navy
taglia junior e senior
Winter Cap
size junior and senior



Art. 07761A
Giacca pioggia con marsupio
taglie dalla XXXS alla XXL
colori: navy, rosso e nero
Rain Jacket - sizes XXXS to XXL
colors: blue, red and black



Art. TSG10/TSG11
T-SHIRT colori: bianco, nero, rosso,
verde, giallo, arancio, blu, royal
misure: bambino dalla S alla XL adulto dalla S alla XXL,
neutra oppure personalizzata con logo ad un colore
(ordine minimo per la personalizzazione 50 pezzi)
T-Shirt various colors and size, also with your logo on request
(minimum order for customization 50 pieces)

Art. SB099

TUBOLARE BARRET in microfibra 108 dinari

Prodotto tecnico brevettato come modello d'uso CEE - Made in Italy

Lascia traspirare la pelle e ripara dal freddo e dal vento

utilissimo in molteplici situazioni:

durante e dopo gli allenamenti, durante gli incontri, per sostenere la tua squadra, nel tempo libero, in moto etc.

Barret TUBOLAR HAT in microfiber - made in Italy patented

BTH lets your skin breath while protecting you from cold and wind

you can wear it during or after training, during the game, in your spare time, to support your team, when riding your bike etc.

utilizzabile come scaldacollo, foulard, bandana, fascia, passamontagna etc.



it can change shape from neck warmer to head band to foulard to bandana

**PRODOTTO
TECNICO**
**TECHNICAL
PRODUCT**



A differenza del comune prodotto in pile, la microfibra del Tubolare Barret impedisce il surriscaldamento e l'eccessiva sudorazione della pelle, grazie alla sua speciale traspirazione e leggerezza

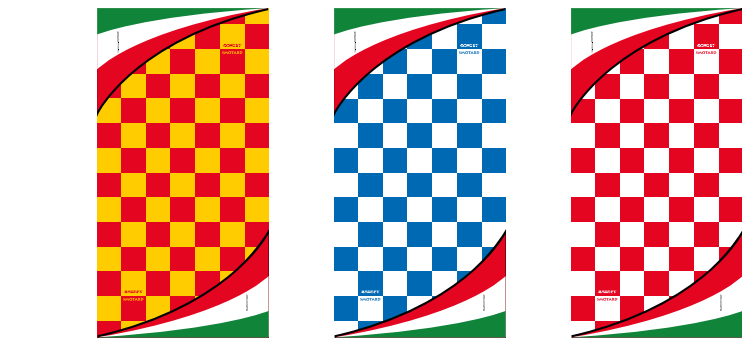
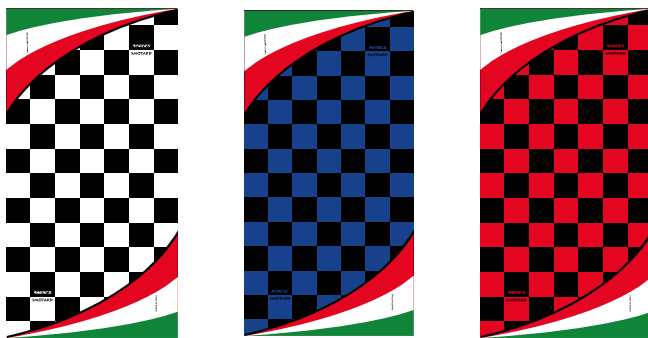
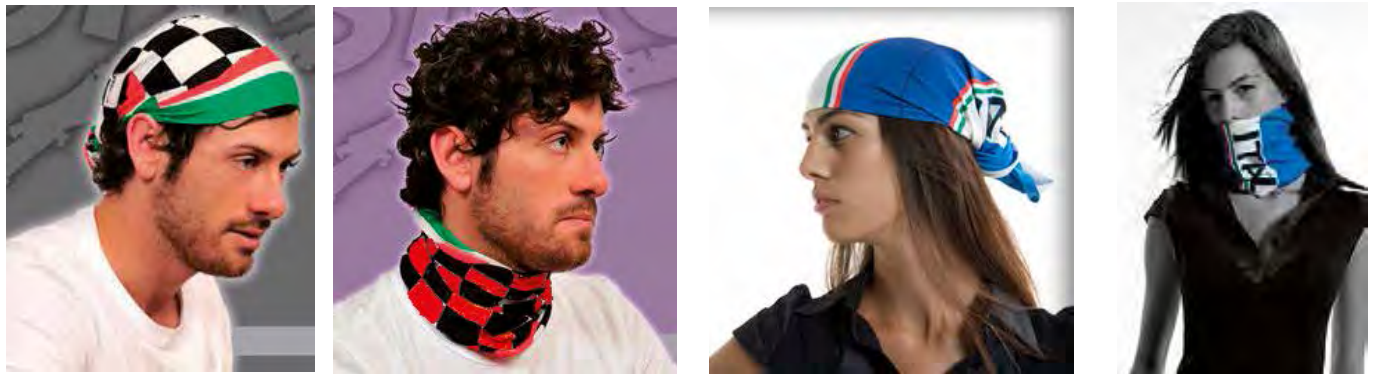

Colori disponibili:
bianco/nero, nero/azzurro, rosso/nero, bianco/celeste, bianco/rosso, giallo/rosso, azzurro nazionale italiana (prodotto personalizzabile su richiesta per ordine minimo di 100 pezzi, con spese per elaborazione grafica da definire)

Colors available as in the pictures Barret tubolar HAT can be personalized with your logo and colors with a minimum order of 100 pieces (graphic work not included in the price)

NUMERAZIONI TERMOSALDABILI NUMBERS FOR UNIFORMS

Colori disponibili: bianco, giallo, rosso, verde, royal, blu, granata, nero, oro, argento
Available colors: white, yellow, red, green, royal, blue, brown, black, gold, silver

Art. PN23



Art. PN18



Art. PN10



pg.17

Art. PG23

Numeri termosaldabili Serie Omega h.23 cm. in confezione da 1 a 22
Numbers for sport uniforms Omega series 23 cm. height package from number 1 to number 22

Art. PG18

Numeri termosaldabili Serie Omega h.18 cm. in confezione da 1 a 22
Numbers for sport uniforms Omega series 18 cm. height package from number 1 to number 22

Art. PG10

Numeri termosaldabili Serie Omega h.10 cm. in confezione da 1 a 22
Numbers for sport uniforms Omega series 10 cm. height package from number 1 to number 22

Art. PN23

Numeri termosaldabili Serie Omega h.23 cm. numeri singoli (da 0 a 9)
Single numbers for sport uniforms Omega series 23 cm. height (from 0 to 9)

Art. PN18

Numeri termosaldabili Serie Omega h.18 cm. numeri singoli (da 0 a 9)
Single numbers for sport uniforms Omega series 18 cm. height (from 0 to 9)

Art. PN10

Numeri termosaldabili Serie Omega h.10 cm. numeri singoli (da 0 a 9)
Single numbers for sport uniforms Omega series 10 cm. height (from 0 to 9)



TEMPERATURA MASSIMA 135 °C
TEMPO MASSIMO DI APPLICAZIONE
6 SECONDI
MAXIMUM TEMPERATURE 135 °C
MAXIMUM 6 SECOND PRINT

Art. PG4

Numeri termosaldabili Serie Omega h.4 cm. in confezione blister numeri da 1 a 100 colore bianco, blu o nero
La numerazione progressiva (di 100 in 100) arriva fino a 500
Numbers for sport uniforms Omega series 4 cm. height package from number 1 to number 100 black, blue or white color

TACCHETTI ED ACCESSORI PER SCARPE - Studs and Shoe accessories



Art. 265bis / 268bis / 270bis

Tacchetto alluminio conico mm. 14-17-19
Conical aluminium Stud 14-17-19 mm.



Art. 262/263/264/265/266/267/268/269/270

Tacchetto alluminio conico tornito
Milled conical aluminium Stud
mm. 11-12-13-14-15-16-17-18-19



Art. A11 / A13 / A15 / A17

Tacchetto alluminio conico tornito
Argentinos superleggero serie A
mm. 11-13-15-17

Milled conical aluminium Stud
ultra-light Serie A
11-13-15-17 mm.

pg.15



Art. BACS / BACSC
Blister tacchetti in
alluminio conici con/
senza rondelle e chiave
Blister pack
conical aluminium
studs with/without key
and washers

pg.14



Art. PR11 / PR14 / PR17

Tacchetto alluminio conico tornito
punta rinforzata mm. 11-14-17

Conical aluminium Stud
reinforced tip 11-14-17 mm.



Art. CHAZ
Chiave in
acciaio zincocromata
Stud Key



Art. 292 / 293 / 294 / 294bis
mm. 11, 13, 15, 17

Tacchetto in nylon conico punta rinforzata in alluminio
Conical Nylon stud with reinforced tip



Art. BNPR1 / BNPR2

Blister tacchetti in nylon
punta rinforzata mm. 11-13-15/
mm. 13-15-17

Blister pack nylon studs with
reinforced tip mm. 11-13-15/
mm. 13-15-17



Art. M204 / M205
Tacchetto in nylon
monocolore
mm. 13 / 16
Nylon Stud
mm. 13 / 16



Art. M203

Blister tacchetti in nylon
monocolore
(nero, rosso, bianco)
Blister pack nylon studs of a
single colour (black, red, white)

pg.15



Art. 35M12 / 35M14

Tacchetto gomma base stretta mm. 12 / 14
Narrow Base Rubber Stud mm. 12 / 14



Art. 302 Base filettata
in alluminio
mm. 7, 8, 10, 12

Art. 302G Base filettata
in alluminio
mm. 13, 14, 17

Threaded aluminium bases

Art. 314 Rondella in alluminio - Aluminium washer



Art. 072.11 / 072.13

Tacchetto gomma base larga
per terreni gelati mm. 11 / 13
Wide Base Rubber Stud - for icy ground



Art. 317 / 318
Paio tendiscarpe a molla,
misura 40-42 / 43-45
 Shoe stretchers with spring,
 size 40-42 / 43-45

pg.15

pg.16

Art. BLS4
Lastrina antitrauma ritagliabile in gel forata
spessore mm.4 dimensioni cm.14x28
da utilizzare a contatto con la pelle del piede
dentro la scarpa in caso di ferite, vesciche o
contusioni: attutisce il dolore derivante dalla
corsa e dall'impatto con la palla

Anti-shock pierced gel thickness 4 mm. size
 cm.14x28 you can cut it and place it inside your
 shoe against the skin to prevent pain from running
 and kicking in case of small foot injuries



Art. 326 / 326FL / 327 / 327FL / 328 / 328FL
Paio lacci per scarpe cm.120-150-180
colori nero, bianco, giallo fluo, verde fluo, arancio fluo
 Pair of shoe laces 120-150-180 cm. long
 colors: black, white, fluo yellow, fluo green, fluo orange

pg.15



Art. SOL.SP
Paio solette in gel
profumate ritagliabili
 Gel Insoles



Art. ALZ.SP
Paio Alzatacco in gel
taglia 1 donna
taglia 2 uomo
 Gel under heel softeners
 woman and man sizes



Art. 21654
Paio solette
Spugna Sport
 Sport Insoles

pg.16



Art. E6694
Paio Alzatacco in silicone
misura S (33/36) - M (37/40)
L (40/44) - XL (44/48)
 Silicone under heel softeners
 various sizes



Art. 238.1

Art. 238



pg.15

Art. S489
Spazzola
in setola naturale
Shoe Brush

Art. 238.1
Grasso Aquila Kg.1
Aquila Grease for shoes
Kg. 1

Art. 238
Grasso Aquila ml. 100
Aquila Grease for shoes
ml. 100

Art. 34071A
Spray
impermeabilizzante
Spray waterproofing



Art. D122X
Spray Dilato ml. 200
ammorbidente
Spray to soften leather
soccer shoes



Art. TE.540.01
Zerbino pulisciscarpe
in plastica con ventose
dimensioni cm.35x27
Shoe cleaning device
in plastic with suckers
dimension 35x27 cm.

pg.16



Art. FA270
Macchina lavascarpe con 4 spazzole sostituibili
getti incrociati regolabili ad alta pressione
completo di poggiamani e 4 fori di fissaggio a terra
in dotazione fascetta in acciaio per collegamento tubo
mm 15x21 (non incluso) alla rete idrica.
Shoe washing device - high pressure crossed water jets
iron frame with handles - replaceable brushes
easy fixing to the floor with 4 holes



PARASTINCHI - Shinguards



Art. PSCV
Paio parastinchi
senza cavigliera
misura adulto e bambino
Pair of shinguards
without ankle protection
junior and senior size

Art. IS30HS

Paio parastinchi
senza cavigliera
misura S-M-L
Pair of shinguards
without ankle protection
size S-M-L



pg.16

**INNOVATIVO PARASTINCO BARRET REALIZZATO CON SPECIALI LISTELLI ANATOMICI
LEGGERRISSIMO MA CON ALTA RESISTENZA ALL'IMPATTO**
BARRET SPECIAL SHINGUARDS anatomic, very light and highly resistant to impact

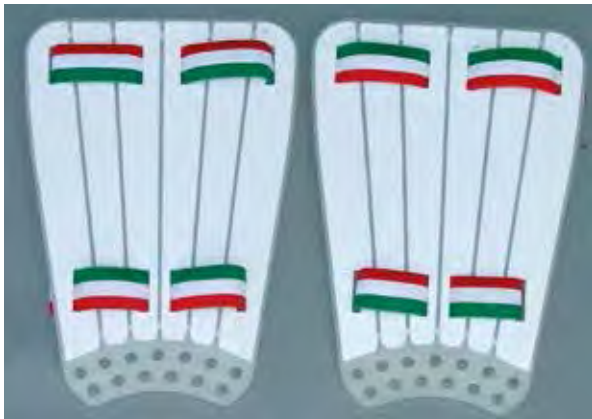

Art. BP90

Paio parastinchi Barret senza cavigliera misura unica
Pair of Barret shinguards without ankle protection
one size fits all



BREVETTATO
PATENTED



Art. PBC
Paio parastinchi
con cavigliera
misura adulto
Pair of shinguards
with ankle protection
senior size



FASCE CAPITANO - GUANTI PORTIERE - Captain's Armbands - GK Gloves



Art. 150
Fascia capitano elastica
misura adulto
Elastic Captain's armband
size adult

Art. 150.B
Fascia capitano elastica
misura bambino
Elastic Captain's armband
size children

pg.17



Art. 150F Fascia capitano elastica
mis. adulto colore giallo o arancio fluo
Elastic Captain's armband adult size
colors: fluorescent yellow and orange



Art. 150V.9
Fascia capitano con velcro, taglia adulto
colori: bianco, rosso, giallo fluo, verde,
blu e arancio fluo - h. cm. 9
Captain's armband adjustable length - 9 cm. height
size adult - colors: white, red, fluo yellow,
blue, green, fluo orange



Art. 150V / 150V.B
Fascia capitano con velcro, taglia adulto o bambino
Modello Champions colori bianco, rosso, giallo, verde,
blu, fucsia, arancio - h. cm. 6,5
Captain's armband adjustable length - 6,5 cm. height
size adult or children
colors: white, red, yellow, blue, green,
fuchsia, orange



Art. 150V.9N
Fascia capitano neutra con velcro, taglia adulto
h. cm. 9 - colori: giallo fluo, giallo, arancio,
bianco, rosso, verde, blu
Captain's armband with no "C" printed
adjustable length 9 cm. height size adult
colors: fluo yellow, yellow, orange, white, red,
green, blue



Art. 1000PG
Paio Guanti portiere misure da 6 a 11
Pair of Goal Keeper Gloves
Size from 6 to 11

pg.16

Art. F30BG
Paio Guanti
portiere junior
misure da 4 a 8
Pair of Goal
Keeper Gloves
Size from 4 to 8



I colori dei guanti raffigurati nelle immagini possono variare

LAVAGNE TATTICHE - Tactical Boards



Art. 087

Lavagna magnetica cm. 60x90 cancellabile con cornice metallica
Tactical board 60x90 cm. magnetic and erasable with metal frame

Art. 087.BO

Borsa per lavagna magnetica Art. 087 cm. 60x90
Bag for tactical board Art. 087 60x90 cm.



Art. M087TP

Treppiede di sostegno in acciaio verniciato per lavagna Art. 087 (lavagna esclusa)

Painted steel tripod for board Art. 087 (board not included)

pg.18



Art. 090RIC

Ricambio 100 fogli cm.70x100 per lavagna Art. 090 (lavagna esclusa)
100 spare sheets for board Art. 090 (board not included)

New!

Art. 090

Lavagna Calcio su treppiede con 100 fogli cm.70x100 (non cancellabili)
Board on tripod with 100 sheets 70x100 cm. (not erasable)

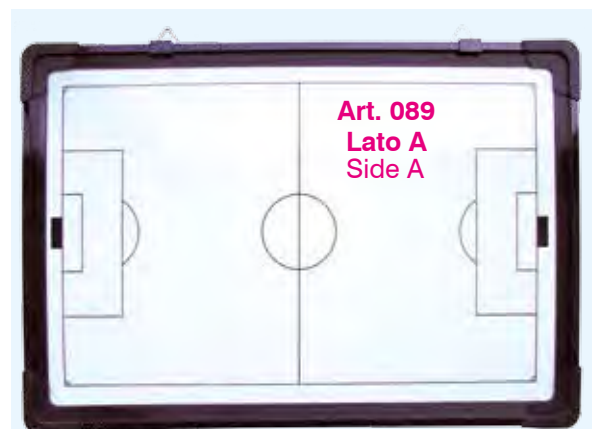

Art. 089
Lato A
Side A

Art. 089

Lavagna magnetica bifacciale cancellabile con borsa cm. 45x30
2 face Tactical Board magnetic and erasable 45x30 cm. with bag



Art. 089
Lato B
Side B

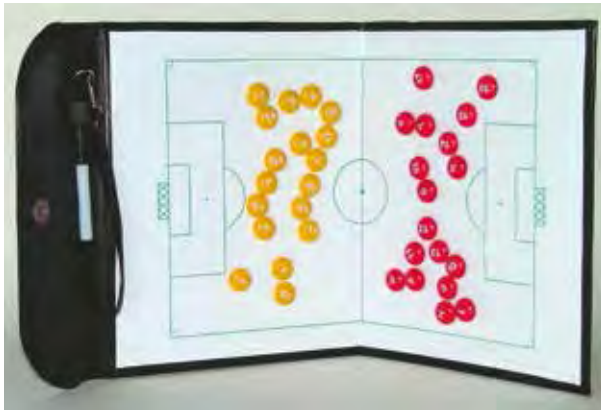

Art. 089-P
Lavagna magnetica cancellabile
pieghevole cm. 46x25
 Foldable Tactical Board magnetic and
 erasable 46x25 cm.

pg.18

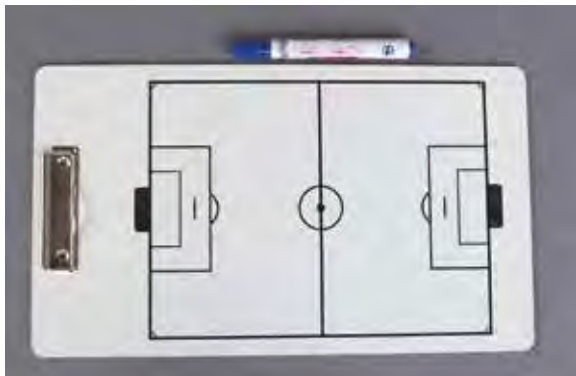

Art. 089-A
Lavagna bifacciale cancellabile cm. 40x23
 2 face Tactical Board erasable, 40x23 cm.



Art. CSRK
Lavagna Tattica magnetica cancellabile
con block-notes cm. 40x23
 Magnetic Tactical Board 40x23 cm. erasable

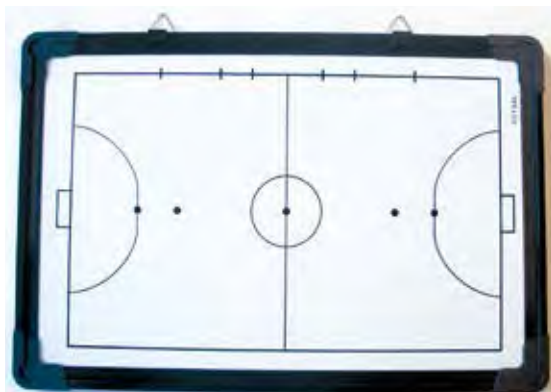

Lato A
 Side A

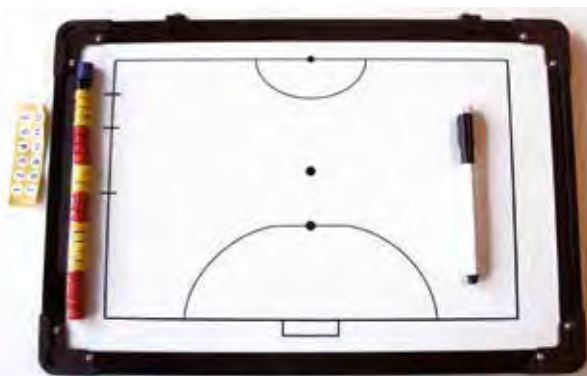

pg.19

Lato B
 Side B

Art. 089CM
Lavagna Tattica Calcio bifacciale magnetica e cancellabile cm. 45x30
 2 face Futsal Tactical Board magnetic and erasable 45x30 cm.



Art. 089-C
Lavagna Tattica
Calcetto bifacciale
cancellabile
cm. 40x23
 2 face Futsal
 Tactical Board 40x23
 cm. erasable



Art. PM
Serie pedine magnetiche
di ricambio
 Spare magnetic pieces
 for Tactical boards



pg.18

Art. PAL-B
Pal Block - blocco
tascabile con 25 pagine
copertina cancellabile
 Pocket block-notes
 25 pages with erasable cover



Con lavagna cancellabile sulla retrocopertina

140 pagine



Art. DALT DIARIO ALLENAMENTO per l'allenatore di calcio con lavagna tattica

Lo strumento ideale per programmare e registrare durante il corso della stagione tutto ciò che riguarda la preparazione fisica generale, specifica e speciale, i test di valutazione, la preparazione psico-tattica teorica e pratica, la preparazione psico-cinetica, gli esercizi tecnico-tattici, il riscaldamento, il defaticamento e la preparazione post-infortunio della Vostra squadra di calcio e dei singoli giocatori che la compongono.

E' inoltre fondamentale per l'annotazione di tutto ciò che riguarda le partite amichevoli e le partite di campionato, in relazione agli avversari da incontrare.

Il diario è corredato di una retrocopertina pieghevole utilizzabile come lavagna tattica cancellabile a 3 facce



pg.19



Art. 18330

Lavagna magnetica cancellabile pieghevole Multisport (Calcio, Basket, Volley, Rugby, Badminton, Tennis, Floorball etc.) dimensioni cm. 32x22

Multisport Foldable Tactical Board magnetic and erasable 32x22 cm.

MATERASSINI - Mats

Art. 044
Materassino pieghevole
alta densità
cm. 180x50x0,7
Folding foam Mat
high density
180x50x0,7 cm.

Art. 044-A
Materassino pieghevole
alta densità
cm. 180x60x0,7
Folding foam Mat
high density
180x60x0,7 cm.

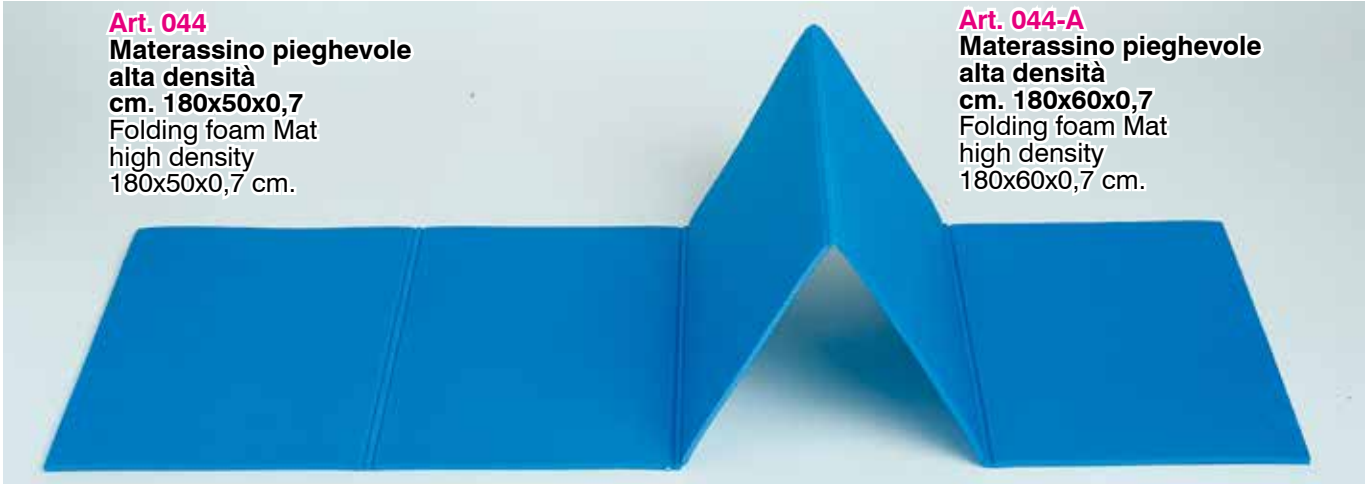

pg.17

Art. 044-R
Materassino arrotolabile
alta densità
cm. 180x50x0,6
Rolled foam Mat
high density 180x50x0,6 cm.

Art. AS803
Materassino Exercise Mat
imbottito e serigrafato cm.180x60x2,5
PVC Mat 180x60x2,5 cm.



Art. 30924
Materassino arrotolabile Yoga
cm. 172x60x0,4
Rolled Yoga Mat 172x60x0,4 cm.

GHIACCIO - TAPE - CREME - OLI Ice - Tape - Creams - Oils



Art. 164
Ghiaccio spray
ml. 400
Ice spray 400 ml.



Art. 165
Ghiaccio
in busta monouso
Ice in envelope



Art. NE2.5
Nastro economico cm. 2,5x13,7 mt
Tape cm. 2.5x13,7 mt.

Art. NE5
Nastro economico cm. 5x13,7 mt
Tape cm. 5x13,7 mt.

Art. N2.5
Nastro tipo Strappal cm. 2,5x10 mt
Tape Strappal cm. 2,5x10 mt.

Art. N5
Nastro tipo Strappal cm. 5x10 mt
Tape Strappal cm. 5x10 mt.



Art. 9254
Salvapelle
Skin Protection

● pg.18



Art. IDNC38
Nastro adesivo colorato fermacalze
cm. 3,8x13,7 mt.
colori: rosso, nero, blu, verde e giallo
Coloured Tape stop stockings
in red, black, blue, green and yellow



Art. TPG09
Fraplast cm. 8 (Tensoplast)



Art. IPT02
Forbice
taglia taping
in acciaio inox
Scissors for taping



Art. T255
Kinesio Tape



Art. IPT01
Cutter taglia bendaggi
Cutter for bandages



Art. ONC
Olio riscaldante 500 ml
stimola la circolazione,
tonifica la muscolatura,
previene le lesioni muscolari
microtraumatiche
Oil 500 ml
for muscle warm up, stimulating
blood circulation
and preventing micro injuries



Art. CNC
Crema riscaldante 250 ml
stimola la circolazione,
tonifica la muscolatura,
previene le lesioni muscolari
microtraumatiche
Cream 250 ml
for muscle warm up, stimulating
blood circulation and preventing
micro injuries



Art. IRVF
Vaselina filante
per curare le zone della pelle a
maggiore sollecitazione
Vaseline avoiding skin problems



Art. IRFA
Fango argilla per impacchi
dopo distorsioni,
per assorbimento ematomi
Special mud to be used after
injuries (i.e. sprained ankles)
and to absorb bruises

pg.18



Art. IJGE
Crema Jel Gestic
coadiuvante per
infiammazioni, contusioni
e lesioni dell'apparato
muscolare
Cream Jel Gestic
for treating minor injuries
and sore muscles



T10R
GEL FREDDO
refrigerante
immediato su
contusioni o
strappi muscolari
Cold Gel for
immediate
application on
bruises and sore
muscles

T17G
CUSCINETTO
IN GEL
dim. cm.17x27
(effetto freddo
ed effetto caldo)
Gel Pillow
17x27 cm.
(both for cold
and hot therapy)

BORRACCE - Water Bottles



Art. K8
Borraccia da 1 litro
1 liter Water Bottle

Certificate per uso alimentare
Food grade certified

pg.17 pg.18



Art. B500ML
Borraccia da ½ litro
½ liter Water Bottle



Art. 308.C
Cestello per 6 Borracce in plastica
Holder for 6 water bottles in plastic



Art. 306
Kit 6 Borracce da 1 litro con cestello
Kit 6 one liter water bottles with holder



Art. OC8
Cestello per 8 Borracce in plastica pieghevole
Foldable Holder for 8 water bottles in plastic



Art. K8S6
Kit 8 Borracce da 1 litro con cestello pieghevole
Kit 8 one liter water bottles with foldable holder



Art. IRTT
Distributore termico 6 litri con rubinetto
Thermos 6 liter with tap

COMPRESSORE - POMPE - MANOMETRI - CRONOMETRI Inflator - Pumps - Gauges - Chronos



Art. 106
Compressore
elettrico 220 Volt
con borsa
Electric Inflator
220 Volt
with bag



Art. 107
Manometro misura pressione palloni con valvola
(con indicazione pressioni consigliate per i vari sport)
Pressure Gauge with valve
(with indication of pressure for different sport balls)



Art. US107
Manometro misura pressione palloni alta precisione
con valvola (con indicazione
pressioni consigliate per i vari sport)
High precision pressure Gauge with valve
(with indication of pressure for different sport balls)



Art. 104-A Pompa con ago - Pump with needle



Art. PSS
Pompa a staffa
con serbatoio
All purpose
Pump with tank

● pg.19 ● pg.20



Art. 2005
Confezione 12 Aghi
con valvola
per gonfiaggio palloni
Set 12 Needles
with valve
for inflating balls

Art. 2005RC
Ago di ricambio
per compressore Art. 106
Spare needle
for electric inflator Art. 106



Art. 104-T
Pompetta in gomma soft
con ago e valvola di sfiato
ideale per gonfiaggio
palloni in gomma
Soft Pump with needle
and valve
for inflating rubber balls

BANDIERINE - Flags



Art. 074
Kit completo
4 paletti
calcio d'angolo
con snodo
in PVC Ø mm.32
(bandierine colore
giallo o rosso)
Kit 4 complete
flexible Corner Poles
in PVC Ø 32 mm.
(yellow or red flags)



Art. 074RP
Kit completo
4 paletti
calcio d'angolo
con snodo
rinforzati con tubo
in polipropilene
Ø mm.40
(bandierine colore
giallo o rosso)
Kit 4 complete
flexible Corner
Poles reinforced
with polypropylene
pipe Ø 40 mm.
(yellow or red flags)

pg.19



Art. 073
Kit completo
4 paletti calcio d'angolo
in PVC Ø mm.32
(bandierine colore giallo o rosso)
Kit 4 complete Corner Poles
in PVC Ø 32 mm.
(yellow or red flags)



Art. 368

Art. 368 Set ricambi
4 Bandierine calcio d'angolo
colore giallo o rosso
Set of 4 spare Corner Flags
yellow or red color



Art. 076



Art. 075

Art. 075 / 076

Coppia Bandierine segnalinee gialle o a scacchi con aste in plastica
Pair of linesman's Flags yellow or checked with plastic sticks

pg.19



Art. 367-G

Art. 367-S

Art. 367-G / 367-S

Coppia ricambi Bandierine segnalinee gialle o a scacchi
Pair of spare linesman's Flags yellow or checked



Art. 13ALC

Coppia Bandierine segnalinee a scacchi fluorescenti con aste in alluminio e custodia
Pair of linesman's Flags fluorescent with aluminium sticks and holder



Art. 172

Coppia Bandierine segnalinee elettroniche complete di ricevitore e valigetta
Pair of electronic linesman's Flags complete with signal receiver and case

pg.19

ACCESSORI ARBITRO - Referee's accessories



Art. 078
Fischio Fox 40 Classic senza pallina
nero o colorato
Whistle FOX 40 Classic

078PD
Fischio arbitro senza pallina
Fox 40 Classic CMG nero o
colorato con imboccatura
anatomica e cordoncino
Whistle FOX 40 Classic CMG
cushioned mouth grip
(cord is included)

pg.19



Art. 078SK
Fischio Fox 40 SONIK BLAST
CMG con cordoncino - vari
colori, con due camere sonore
Whistle FOX 40 SONIK BLAST
CMG with cord, various colors



Art. 078CH

Fischio senza pallina nero o colorato con cordoncino in confezione blister
Plastic whistle without a ball various colors with cord

pg.19



Art. 228C
Fischio in plastica
nero con cordoncino
Plastic black whistle with
cord

Art. 228
Fischio in plastica nero
senza cordoncino
Plastic black whistle
without cord



Art. 079C
Fischio cromato
con cordoncino
Chromed brass
whistle with cord



Art. FEFOX
Fischio elettronico
Fox 40 con cordoncino
potenza 125 dB
Electronic Fox 40 whistle
with cord



Art. 080
Cordoncino Lanyard
colore nero
Nylon
whistle cords Lanyard
black color

pg.19



Art. F40CAP
Cordoncino Fox antipanico
regolabile, vari colori
Fox whistle cord adjustable
various colors



Art. 9816
Polsino regolabile
per fischietto Arbitro
Adjustable wristband
for referee's whistle



Art. KCPFOX
Kit cronometro da polso
e fischietto Fox 40 Sonik
Blast con cordoncino
Kit wrist Chronometer with
Fox 40 Sonik blast whistle
with cord



Art. 081F Coppia cartellini con
custodia, matita e tabellino gara
Yellow and red cards with holder,
pen and game note card

Art. GR15
Coppia cartellini
giallo e rosso
riscrivibili con pennarello
(cancellabili con alcol)
Rewritable yellow
and red cards with pen
(erasable with alcohol)



pg.19



Art. 880147
Moneta per arbitro
in plastica
rosso/nera
referee's coin



Art. RYC02
Set 1 cartellino arbitro giallo e 1 rosso
Set 1 yellow and 1 red card for referee



Art. RCB
Cartellino arbitro blu
Blue referee card

SEGNALATORI MANUALI ED ELETTRONICI PER SOSTITUZIONI Manual and electronic Substitution Boards

Lato A
Side A



Lato B
Side B



Art. C00937
Segnalatore bifacciale per cambio giocatori manuale fluorescente - base in plastica lucida
Substitution indicator fluorescent 1 piece 2 sides

Art. 071
Serie numeri cambio giocatori (da 1 a 25) senza manico
Numbers for substitution (from 1 to 25) without handle



Art. 072
Serie numeri cambio giocatori (da 1 a 25) con manico
Numbers for substitution (from 1 to 25) with handle



pg.20

Art. 072-D
Doppia serie (rossa e verde) di numeri da 1 a 99 per sostituzione giocatori con manico (disponibile fino ad esaurimento scorte)
Double set of numbers (red and green) from 1 to 99 for substitution, with handle (until available in stock)



Art. F292-30
Valigetta cm. 61x40x8 per Art. FINOUT4 e FINOUT8
Case 61x40x8 cm. for Art. FINOUT4 and FINOUT8

Art. FINOUT4
Tavoletta elettronica bicolore, monofacciale a 4 cifre (2+2) - led verdi per giocatore entrante led rossi per giocatore uscente, completa di caricabatteria - dim. cm. 58x38x2,7 kg. 2,2
4 Digit Electronic Substitution Board
1 side 2 color leds (red and green) cm.58x38x2,7 Kg. 2,2 with battery charger

Art. FINOUT8
Tavoletta elettronica bicolore, bifacciale a 4 cifre (2+2) - led verdi per giocatore entrante led rossi per giocatore uscente, completa di caricabatteria - dim. cm. 58x38x2,7 kg. 2,25
4 Digit Electronic Substitution Board
2 sides 2 color leds (red and green) 58x38x2,7 Kg. 2,25 with battery charger

Art. 065-EC

**Tavoletta elettronica bifacciale, bicolore
DELTA 2FE1 cm.46x33x1,8 Kg.1,5**
4 digit Electronic substitution Board
2 sides - 2 color leds (red and green)
battery charger included

Art. EC-VG

Valigetta per Art. 065-EC - Bag for Art. 065-EC

UEFA
APPROVED
PRODUCT



New!

pg.20

Art. D2FE

**Tavoletta elettronica
bifacciale, bicolore DELTA 2FE
completa di valigetta e caricabatteria**
cm. 64,5x39x2,5 kg. 2,8
UEFA Electronic substitution Board
2 sides - 2 color leds
bag and battery charger included

UEFA
APPROVED
PRODUCT

UEFA
APPROVED
PRODUCT

Art. 065-F

**Tavoletta elettronica approvata UEFA/FIFA
bifacciale, bicolore a 4 cifre DELTA 2F
completa di valigetta e caricabatteria**
led rossi e verdi - cm. 64x39x3 kg. 3
4 digit UEFA/FIFA Electronic substitution
Board 2 sides - 2 color leds (red and green)
bag and battery charger included





Art. CRN.G
Cronometro digitale 1/100 sec.
 con visualizzazione di ora,
 calendario, sveglia,
 avvisatore sonoro
 Digital Chronometer 1/100 sec.
 displays hour, calendar, timer

Art. CRN.E
Cronometro digitale
 1/100 sec.
 Digital Chronometer
 1/100 sec.



**I MODELLI
 DEI CRONOMETRI
 POSSONO
 VARIARE
 MODELS MAY
 CHANGE**



pg.20

Art. CR032
**Cronometro al
 quarzo**
a 30 memorie
resistente all'acqua
 Quartz Chronometer
 30 memories
 water resistant



Art. GMT Contametri fino a m. 9999
 Meter Counter (until m. 9999)



Art. CR031
Cronometro al quarzo a 500
memorie resistente all'acqua
 Quartz Chronometer
 500 memories - water resistant



Art. PR20
Rotella Metrica
in fibra m. 20
 Fiber measuring tape 20 m.

Art. PR50
Rotella Metrica
in fibra m. 50
 Fiber
 measuring tape
 50 m.

Art. PR100
Rotella Metrica
in fibra m. 100
 Fiber measuring tape 100 m.

PALLONI CALCIO - Soccer Balls



pg.21



Art. GPA4 / GPA5

Pallone calcio Gems Viper Olimpico da allenamento in PU n. 4 e n. 5 vari colori

Ball Gems in PU size 4 and 5 various colors

Art. GPF4 / GPF5

Pallone calcio Gems Viper Olimpico da allenamento in PU n. 4 e n. 5 GIALLO FLUO

Ball Gems in PU size 4 and 5 fluorescent yellow

Art. GPRP5

Pallone calcio Gems Raptor da gara in TPU n. 5

Ball Gems in TPU size 5



pg.20



New!



pg.21

Art. F4V1700 / F5V1700

Pallone calcio da allenamento Molten misto PVC-PU n. 4 e n. 5 (ad esaurimento)
Molten training ball PVC/PU size 4 and 5 (until available)

Art. 1000MS5

Pallone calcio da allenamento Molten misto TPU 1000MS n. 5 (Europa League 2018-2019)
Molten training ball TPU size 5 (Europa League)

Art. NKPA4 / NKPA5

Pallone calcio Nike Pitch Team colore bianco o arancio n. 4 e n. 5
Nike training ball size 4 and 5

pg.21



Art. GPRZX

Pallone calcio Gems Raptor ZX da gara FIFA Quality Pro in PU n. 5
Ball Gems in PU size 5



Art. F5V48TR

Pallone calcio Molten n. 5 F5V4800 "Trofeo" per allenamento professionisti e gare ufficiali categorie inferiori
Molten Soccer Ball F5V4800 "Trofeo" size 5

pg.20



Art. F5V4800

Pallone calcio Molten n. 5 F5V4800
FIFA approved
Molten Soccer Ball F5V4800 size 5
FIFA approved

PALLONI CALCETTO, DA PALLEGGIO E SPECIALI - Futsal and rubber balls



pg.22

Art. M13189

Pallone Mondo n. 1
Ball Mondo size 1

New!



pg.21

Art. GPPC3

Pallone Gems Bomber
Primi Calci in TPU n. 3
Ball Gems in TPU size 3



Art. GBLD

Pallone calcetto Gems
Blade a rimbalzo
controllato n. 4
Futsal Ball Gems size 4



Art. GBLD.ZX

Pallone calcetto Gems Blade ZX
ibrido top quality
a rimbalzo controllato n. 4
(ad esaurimento)
Futsal Ball Gems size 4
(until available)



Art. GPCV

Pallone calcetto Gems Vertigo
a rimbalzo controllato n. 4
Futsal Ball Gems size 4

New!



Art. GPCVOF

Pallone calcetto Gems Vertigo Official
a rimbalzo controllato n. 4
Futsal Ball Gems size 4

Art. F100B
Pallone calcetto AGLA
Bola F100 rimbalzo
controllato in
pelle sintetica
(ad esaurimento)
Futsal Ball
AGLA Bola F100
(until available)



Art. M390P

Pallone calcetto Molten
modello F9G1900
rimbalzo controllato
(Atrax)
Molten Futsal Ball F9G1900

Art. MTHO

Pallone calcetto Molten
modello F9G4801
rimbalzo controllato
(Thorax)
Molten Futsal Ball F9G4801

**CALCIO
A 8**



pg.21

Art. GPC8

Pallone calcio a 8 Gems Raptor C8
in PU n. 4,5
Ball Gems in PU size 4,5



Art. 26854

Pallone feltro indoor n. 4
a rimbalzo normale
Indoor Ball size 4



Art. 45862

Pallone feltro indoor
n. 4 a rimbalzo controllato
Indoor slow rebound
Ball size 4



Art. UL46-3
Pallone calcetto
in gomma TRIAL triplo
strato rimbalzo controllato
gr.380 - diam. cm.19,9
 Futsal Ball slow rebound
 Trial rubber



Art. 1935S
Pallone calcio in gomma
monostrato n. 3
colore giallo
 Rubber soccer Ball
 single stratum size 3
 color yellow



Art. BYCC 
Pallone calcio bicolore
gomma Trial Ø cm.21,5 gr. 420
 Trial rubber bicoloured ball



Art. V45/V44/V42/V41/V40
Palloni calcio in gomma Trial monostrato n. 1 - 2 - 3 - 4 - 5
 Rubber soccer Balls single stratum Trial size 1 - 2 - 3 - 4 - 5

 pg.21



**Art. UL42-3/UL41-3/
 UL40-3**
Palloni calcio in gomma
Trial triplo strato
n. 3 - 4 - 5
 Rubber soccer Balls
 triple stratum Trial
 size 3 - 4 - 5

**Art. ULTST3/ULTST4/
 ULTST5**
Palloni Trial SILVER
STREET n. 3 - 4 - 5
doppio strato
 SILVER STREET Trial balls
 size 3-4-5 double stratum



Art. TRILO
Pallone calcio Trial
TRILO n. 4,5
doppio strato
limita il trauma dovuto
all'impatto con la palla
 Soccer Ball Trial TRILO
 size 4,5 double stratum
 softens ball contact



Art. B703390
Pallone in pelle sintetica gr.1000
Training Ball
in synthetic leather 1000 gr.



Art. ULTS40
Pallone in gomma Trial
allenamento potenziato doppio strato
Ø cm.21,5 gr.630 (+50%)
Trial heavy rubber ball double stratum



Art. ULTD40
Pallone in gomma Trial
allenamento potenziato
doppio strato
Ø cm.21,5 gr.840 (+100%)
Trial heavy rubber ball
double stratum

pg.22



Art. TRBC
Pallone reaction ball Trial
doppio strato rimbalzo e traiettorie
imprevedibili per calcio
Trial Reaction Ball unpredictable rebounds
for soccer double stratum



Art. B703315
Pallone per allenamento portieri
rimbalzo irregolare in pelle sintetica
Crazy Goal-Keeper Ball
irregular rebounds in synthetic leather



Art. B703316
Reflex ball
pallone prismatico
in pelle sintetica
Prismatic ball in
synthetic leather



Art. 149S14
Pallone in
gommapiuma Ø cm. 14
Foam rubber ball Ø 14 cm.

pg.21



Art. 149S
Pallone in
gommapiuma Ø cm. 20
Foam rubber ball Ø 20 cm.



Art. E48
Pallone sonoro Trial
per non vedenti
Ø cm.22 - gr.470
Trial rattle ball for blind people

pg.22

PALLE MEDICHE A MASSA FISSA E OSCILLANTE - Classic and Dynamic Medicine Balls



**Art. AHF-105 / AHF-106 /
AHF-107 / AHF-108 / AHF-109**

**Palle Mediche
rigonfiabili e rimbalzanti
Kg. 1 - 2 - 3 - 4 - 5
ad alto grip colore nero
Medicine Balls
inflatable and rebounding
high grip in black color**

pg.22



Art. 048 / 050 / 051 / 052 / 053

**Palle Mediche rigonfiabili
e rimbalzanti Trial
kg. 1 - 2 - 3 - 4 - 5
(il colore varia
a seconda del peso)
Trial Medicine Balls
inflatable and rebounding
different colors for different weights**



pg.23

**Art. WMD100 / WMD200 /
WMD300 / WMD400 / WMD500
Palle Mediche morbide Bubble
Trial - kg. 1 - 2 - 3 - 4 - 5
Soft Trial Medicine Bubble Balls
kg. 1 - 2 - 3 - 4 - 5**

Art. AHF-048/.../AHF-097

**SLAM BALL
kg. 2 - 3 - 4 - 5 - 6 - 7 - 8
9 - 10 - 12 - 15**



pg.23



Art. AHF-117/.../AHF-125

**WALL BALL
kg. 3 - 4 - 5 - 6 - 7 - 8
9 - 10 - 12**



pg.12

pg.13

Art. KEB4/KEB6/KEB8/KEB10/KEB12/KEB16/KEB20/KEB24

**Kettlebell in ghisa verniciata con base in gomma
kg. 4 - 6 - 8 - 10 - 12 - 16 - 20 - 24
Painted cast iron Kettlebells - rubber base**



Art. OV500 / OV1 / OV2 / OV3 / OV4 / OV5

**Over ball Trial kg.0,5 - 1 - 2 - 3 - 4 - 5 con impugnatura anatomica
Over ball TRIAL**



pg.22

Art. POL1 / POL1.5 / POL2 / POL3 / POL3.5

**POLIBOLO - Over ball Trial a massa oscillante (riempite con acqua distillata) peso kg.1 - 1,5 - 2 - 3 - 3,5
POLIBOLO TRIAL - Over ball filled with distilled water - weights 1 - 1,5 - 2 - 3 - 3,5 Kg.**

**Le Over ball e le Polibolo possono essere utilizzate sia come manubri sia come palle mediche
Over Balls and Polibolos can be used both as dumb bells and medicine balls**

pg.23

PALLE RITMICHE, PSICOMOTORIE E LUDICHE - Rhythmic and Gym Balls



pg.21

pg.22

Art. 518S Palla Ritmica Mondo gr. 400 (fino ad esaurimento scorte)
Mondo Rhythmic Ball 400 gr. (until available in stock)



Art. 42R/44R/46R/48R Palle Ritmiche Trial - Trial Rhythmic Balls gr. 420-320-240-150



**Ideali per trattamento
fisioterapico,
equilibrio, stretching,
tonificazione, attività
aerobica, scarico
vertebrale,
riscaldamento,
potenziamento
muscolare ...**

Very useful for injury
recovery, equilibrium,
stretching, muscle
training, aerobic activity,
warm up ...



Art. 30934/30935/30936/31036

Palle psicomotorie monostrato

Gym balls single stratum various colors

Ø cm. 55

Ø cm. 65

Ø cm. 75

Ø cm. 85

pg.23



**Art. V10/V11/V12/V13/V14/V15/
V16/V17/V18/V19**

**Palle psicomotorie Trial in
gomma doppio strato
(il colore varia
a seconda del diametro)**

Trial Gym balls
in double stratum rubber

Ø cm.14-18-22-30

42-53-65-90-120-150

pg.24

Art. V-LAB

**Palla psicomotoria Trial La Ball
con range di possibile utilizzo
da cm.50 a cm.70**

**struttura instabile in gomma doppio
strato particolarmente elastica**

Gym ball Trial La Ball

inflatable from 50 to 70 cm.

changing shape concept in very elastic
double stratum rubber



Palloni Linea Sun: Ø cm. 26 peso gr. 320 Ø 26 cm. weight 320 grams

Il diametro maggiorato favorisce l'apprendimento del bambino - Bigger diameter for youngest training and fun



Art. AL01 Big Sun
Fase di volo più lenta
Slower in the air



Art. AL02 Foot Sun
Per stimolare la tattilità del bambino
To stimulate children's touch



Art. AL03 Crazy Sun
Cambia direzione ad ogni rimbalzo
Irregular rebounds

pg.22



Art. ULTbbs3
Pallone Jumbo Trial a 3 strati
diam. cm.28 - gr.280
Jumbo Trial Ball triple stratum



Art. BTR1
Palla sensoriale Ø cm. 21 - gr. 420
Sensory Ball Ø cm.21 - gr. 420

Le palle sensoriali rimbalzanti esaltano la tattilità e rappresentano anche uno strumento di automassaggio a pressione
To stimulate touch and also useful massage tools



Art. BTR2
Palla sensoriale Ø cm.12 - gr. 180
Sensory Ball Ø cm.12 - gr. 180

Allenando la visibilità laterale migliorano la percezione dello spazio, i movimenti e la sicurezza nella vita quotidiana
For space perception, coordination and everyday life safety

pg.8



Art. TLV16
Palle morbide Trial per allenamento della visibilità laterale Set di 6 Palle diametro cm. 16 gr. 110
Soft balls for lateral visibility training Set of 6 balls 16 cm. diameter - 110 gr.

Art. TLV21
Set di 6 Palle diametro cm. 21 gr. 160
Soft balls for lateral visibility training Set of 6 balls 21 cm. diameter - 160 gr.



Art. BS1T
PALLONE BASIC jelly touch Ø 12/16 cm. gr.140 - colore verde
Basic Ball green color

Art. BS2T
PALLONE BASIC jelly touch Ø 16/22 cm. gr.180 - colore arancio
Basic Ball orange color

Art. BS3T
PALLONE BASIC jelly touch Ø 22/28 cm. gr.240 - colore rosso
Basic Ball red color

pg.22

BORSE - Bags

**** VERIFICARE MINIMI D'ORDINE SUL LISTINO PREZZI ****
Minimum required quantity shown on price list

COLORI DISPONIBILI

Art. TOM/TON:

rosso, royal, navy,
nero, verde, amaranto

Colors for Art. TOM/TON:

red, royal, black,
green, navy, amaranthine

Art. TOM

Borsa Grande cm. 45x32x53h.
poliestere 600
Soccer bag large



Art. TON

Borsa Media
cm. 42x30x50h.
poliestere 600
Soccer bag
medium



Art. E

Zainetto doppio fondo poliestere 600
una tasca - cm. 45x23x35h. fondo rigido
colori: royal, nero, rosso,
navy, verde, bordeaux
Rucksack in 6 different colors

pg.24

New!



Art. PRE

Borsa New Premier in poliestere 600
con fondo rigido h. 15 cm. con tracolla e porta nome,
una tasca, dim. cm. 53x32x50h.
colori: navy-royal, nero/grigio, navy/rosso,
nero/verde, navy/giallo
Soccer Bag New Premier in polyester 600 1 pocket size 53x32x50h. cm.
colors: navy/royal, black/grey, navy/red, black/green, navy/yellow

Art. ZMAS

Zainetto
cm. 35x23x47h.
con fondo rigido
poliestere 600
(combinazioni di colori
come borsa New Premier Art. PRE)
Rucksack in 5 different colors
(same like New Premier bag Art. PRE)

**** VERIFICARE MINIMI D'ORDINE SUL LISTINO PREZZI ****
Minimum required quantity shown on price list

New!



Art. TOBPL
Borsa palestra poliestere 600 cm. 62x37x27h.
con tracolla imbottita, lastra rigida sul fondo, 3 tasche
colore nero/grigio, navy/grigio
Gym Bag colors black/grey, navy/grey

Art. TOTRO

Trolley professional in rip-stop 600
2 tasche, tracolla, porta nome, fondo rigido
rivestito dim. cm. 52x34x62h.
colore navy, nero
Trolley colors black, navy



pg.24



Art. TOBPM
Borsa Portamute cm. 64x34x34h.
poliestere 600 - colore navy o nero
Soccer bag for uniforms dim. 64x34x34h. cm.
colors: black, navy



Art. ZBGL
BORSA/ZAINETTO monocolore economica
cm. 36x38 vari colori - serigrafabile su richiesta
Backpack one color with your logo on request



Art. TBMD
Borsa Medica dim. cm. 32x18x48h.
poliestere 600
Bag for First Aid 32x18x48h. cm.



Art. BMD
Borsa Medica dim. cm. 37x29x17
Bag for First Aid 37x29x17 cm.

CESTE PORTAPALLONI - Baskets for balls



Art. FP400

Cesta portapalloni in alluminio cm. 60x60x45h pieghevole con sacca
Basket for balls in aluminium 60x60x45h cm. foldable with bag



Art. F401

Cesta Portapalloni in ferro verniciato cm. 80x55x60h pieghevole
Basket for Balls in painted steel 80x55x60h cm. foldable



pg.24

Art. F402

Cesta Portapalloni in ferro zincato cm. 60x60x90h pieghevole
Basket for Balls in galvanized steel 60x60x90h cm. foldable

Art. F404 Cesta Portapalloni in rete metallica verniciata cm. 70x70x70h pieghevole con lucchetto

Basket for Balls painted with metallic net 70x70x70h cm. foldable, with lock



Art. F403G Cesta Portapalloni in ferro verniciato cm. 100x75x90h pieghevole con lucchetto

Basket for Balls in painted steel 100x75x90h cm. foldable, with lock



Art. F403ZN

Cesta Portapalloni in ferro zincato cm. 100x75x90h pieghevole con lucchetto

Basket for Balls in galvanized steel 100x75x90h cm. foldable, with lock



Art. NCPN

Cesta portapalloni in nylon con maniglie, tracolla e ruote
Bag for balls with handles and wheels



PORTE CALCIO - Soccer Goals



pg.25

Art. 109
Coppia Porte fisse regolamentari in lega leggera costruite secondo lo standard europeo di qualità UNI EN 748 con paletti tendirete posteriori in acciaio, pali sezione mm. 120x100 verniciati con smalto acrilico non tossico, ganci reggirete e bossole per interrimento pali incluse (telaio posteriore di appoggio a terra non incluso)
Pair of regular Goals in light alloy manufactured according to the UNI EN 748 European standard of quality norms.
Pipe section 120x100 mm. painted with non toxic white.
Net holders, rear posts and underground sockets included (ground backframes not included)

Art. 109.G
Coppia ribaltine posteriori alzarete per porte Art. 109 e S109
Pair of liftable ground backframes for Goals Art. 109 and S109 (to keep nets down to the ground and also to raise them up when cutting grass)

Art. SPP45
Set 4 protezioni imbottite h. cm. 200 per paletti posteriori tendirete
Set of 4 soft protections 200 cm. height for net holder posts

Art. MBR15
Set protezioni imbottite rinforzate per coppia ribaltine alzarete
Set of thick soft protections for pair of ground backframes

Art. SPR45
Set protezioni imbottite per coppia ribaltine alzarete
Set of soft protections for pair of ground backframes

ATTENZIONE: in caso di ordine errato da parte del Cliente le porte, una volta consegnate, non possono essere sostituite

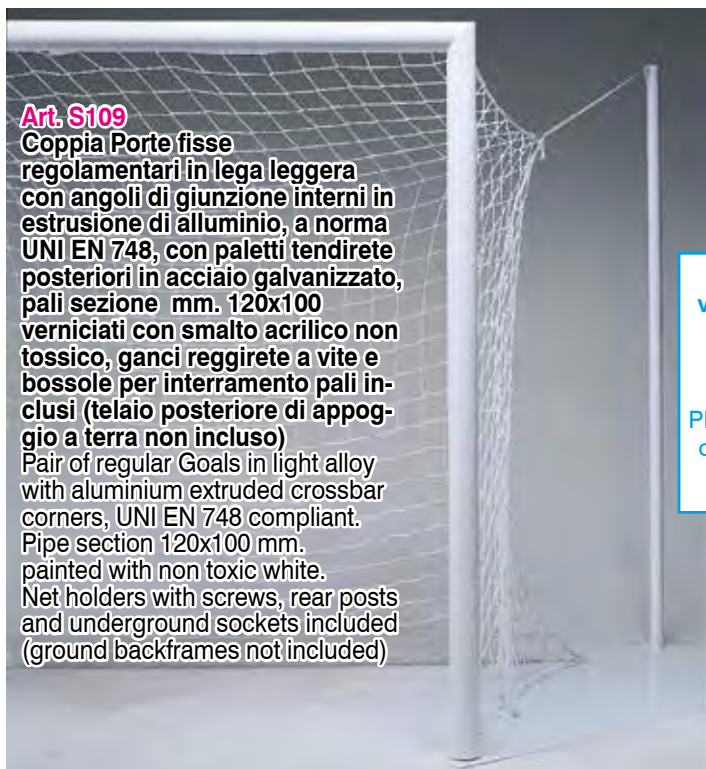

Art. S109
Coppia Porte fisse regolamentari in lega leggera con angoli di giunzione interni in estrusione di alluminio, a norma UNI EN 748, con paletti tendirete posteriori in acciaio galvanizzato, pali sezione mm. 120x100 verniciati con smalto acrilico non tossico, ganci reggirete a vite e bossole per interrimento pali inclusi (telaio posteriore di appoggio a terra non incluso)
Pair of regular Goals in light alloy with aluminium extruded crossbar corners, UNI EN 748 compliant.
Pipe section 120x100 mm. painted with non toxic white.
Net holders with screws, rear posts and underground sockets included (ground backframes not included)

pg.25

Art. 353.G13 / 353.G10
Serie 100 ganci reggirete di ricambio modello a rotazione per porte regolamentari o ridotte

100 spare Net Holders rotating model for regular and reduced goals
2013 or 2010 shape has to be specified

ATTENZIONE:
verificare la tipologia dei ganci delle Vs. porte prima di ordinare i ricambi
Please check the model of your holders before ordering spares



pg.27

Art. 353.G13



Art. 353.G10



Art. 353 Serie 100 ganci reggirete di ricambio modello con vite per porte regolamentari o ridotte
100 spare Net Holders with screws for regular and reduced goals

pg.27



Art. V590010
Serie 100 ganci reggirete di ricambio
100 spare Net Holders



Art. 110BAG
Serie 60 ganci reggirete di ricambio
60 spare Net Holders



Art. 110FG Coppia Porte Trasportabili in lega leggera dimensioni regolamentari profilo sezione mm. 120x100 verniciate con smalto acrilico non tossico base di appoggio posteriore con tubo tondo in ferro - a norma UNI EN 748
Pair of transportable Goals in light alloy regular size, pipe section mm. 120x100 painted with non toxic white - back frame in round iron pipe - UNI EN 748 standard



Art. 120-RG
Coppia ruote per porte trasportabili regolamentari Art. 110FG, 110-D e 110G
Pair of wheels for regular size transportable goals Art. 110FG, 110-D and 110G



pg.25

LE PORTE TRASPORTABILI IN FASE DI GIOCO DEVONO ESSERE ZAVORRATE SULLA BASE POSTERIORE O FISSATE A TERRA CON PICCHETTI PER MOTIVI DI SICUREZZA. LE RUOTE GOMMATE SONO OPTIONAL

Transportable goals must always be anchored to the ground by sacs of sand or metal pegs, for safety reasons. Wheels are optional

Art. 110-D
Coppia Porte Trasportabili dim. regolamentari in lega leggera profilo sezione mm. 120x100 - verniciate con smalto acrilico non tossico base di appoggio posteriore con profilo ovale in alluminio mm. 65x55 - a norma UNI EN 748
Pair of transportable Goals in light alloy regular size, pipe mm. 120x100 painted with non toxic white - back frame in aluminium ovoidal pipe 65x55 mm.



Art. AMCP

Carrello per il trasporto di porte (trasportabili) regolamentari e ridotte - brevettato
Patented trolley for moving official and junior size transportable goals

pg.27



Art. 110G Coppia Porte Trasportabili in lega leggera dimensioni regolamentari profilo mm. 120x100 verniciate con smalto acrilico non tossico, base di appoggio posteriore con profilo in lega mm. 120x100 - a norma UNI EN 748 e FIGC
 Pair of transportable Goals in light alloy regular size, pipe mm. 120x100, painted with non toxic white - back frame pipe 120x100 mm. - UNI EN 748 and FIGC standard



Art. 120-RG Coppia ruote per porte trasportabili regolamentari Art. 110FG, 110-D e 110G
 Pair of wheels for regular size transportable goals Art. 110FG, 110-D and 110G

pg.25

Art. 110GRT Set 4 ruote per porte trasportabili regolamentari Art. 110G (2 set per 1 coppia di porte)
 Set of 4 wheels for regular size transportable goals Art. 110G (2 set for 1 pair of goals)

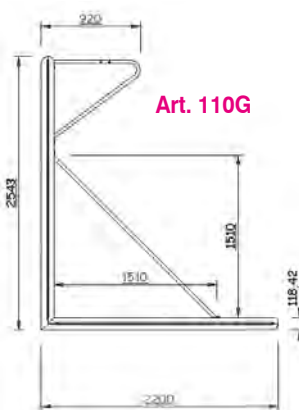

Art. 110G

New!

Art. 4580M Mollone per ancoraggio porte trasportabili regolamentari e ridotte su terreno naturale
 Spring for goal anchoring on natural grass



Art. AFC Zavorra in alluminio per ancoraggio porte trasportabili regolamentari e ridotte
 Aluminium weighted pipes for goal anchoring

ATTENZIONE: in caso di ordine errato da parte del Cliente le porte, una volta consegnate, non possono essere sostituite

Art. DSSCE Sacco zavorra vuoto (da riempire con sabbia) per ancoraggio porte trasportabili regolamentari e ridotte
 Empty Ballast Bag (to be filled with sand) for goal anchoring



Art. DSS20 Sacco zavorra kg. 20 (riempito con sabbia) per ancoraggio porte trasportabili regolamentari e ridotte
 Ballast Bag weight 20 Kg. for goal anchoring

pg.27

Porte fisse (con bossole e pali da interrare) e trasportabili in lega leggera o acciaio, sezione tubo mm. 120x100 o mm.80 - dimensioni m. 3x2 - m. 4x2 - m. 5x2 - m. 6x2

Fixed and transportable Goals in light alloy or painted steel, pipe section 120x100 mm. or 80 mm. dimensions m. 3 x 2 - m. 4 x 2 - m. 5 x 2 - m. 6 x 2

pg.26



Art. 114-T
Art. 118-G
Art. 116-TDV
Art. 120-TG

Con distanziale a terra posteriore in tubo tondo
With round pipe ground base

ATTENZIONE: in caso di ordine errato da parte del Cliente le porte, una volta consegnate, non possono essere sostituite

Art. 114-T

Coppia Porte m. 4 x 2 a traversa intera in acciaio trasportabili tubo sezione 80 mm.
Pair of Goals m. 4 x 2 - 1 piece crossbar in painted steel, transportable, pipe 80 mm.

Art. 118-G

Coppia Porte m. 4 x 2 a traversa intera in lega di alluminio trasportabili tubo sezione 80 mm.
Pair of Goals m. 4 x 2 - 1 piece crossbar in light alloy, transportable, pipe 80 mm.

Art. 116-TDV

Coppia Porte m. 5 x 2 a traversa divisa in lega di alluminio trasportabili tubo 80 mm.
Pair of Goals m. 5 x 2 - crossbar in 2 pieces in light alloy, transportable, pipe 80 mm.

Art. 120-TG

Coppia Porte m. 6 x 2 a traversa divisa in lega di alluminio trasportabili tubo sezione 80 mm.
Pair of Goals m. 6 x 2 - crossbars in 2 pieces in light alloy, transportable, pipe 80 mm.

Art. 118A
Coppia Porte m. 4 x 2 a traversa divisa in lega di alluminio trasportabili tubo 80 mm. con basi posteriori in profilo quadro
Pair of Goals m. 4 x 2 - crossbars in 2 pieces in light alloy, transportable, pipe 80 mm. with square pipe ground bases

Art. 1129A
Coppia Porte m. 5 x 2 a traversa divisa in lega di alluminio trasportabili tubo 80 mm. con basi posteriori in profilo quadro
Pair of Goals m. 5 x 2 - crossbars in 2 pieces in light alloy, transportable, pipe 80 mm. with square pipe ground bases

Art. 1121A
Coppia Porte m. 6 x 2 a traversa divisa in lega di alluminio trasportabili tubo 80 mm. con basi posteriori in profilo quadro
Pair of Goals m. 6 x 2 - crossbars in 2 pieces in light alloy, transportable, pipe 80 mm. with square pipe ground bases



Art. 118A
Art. 1129A
Art. 1121A

Base posteriore a sezione quadro
Reinforced ground base

Scegliere reti con profondità posteriore bassa cm. 160
Pick nets with depth 160 cm. at ground level

LE PORTE TRASPORTABILI IN FASE DI GIOCO DEVONO ESSERE ZAVORRATE SULLA BASE POSTERIORE O FISSATE A TERRA CON PICCHETTI PER MOTIVI DI SICUREZZA. LE RUOTE GOMMATE SONO OPTIONAL

Transportable goals must always be anchored to the ground by sacs of sand or metal pegs, for safety reasons. Wheels are optional



Art. 120-R

Coppia ruote per porte trasportabili ridotte Art. 118A, 1129A, 1121A
Pair of wheels for reduced size transportable goals Art. 118A, 1129A, 1121A

pg.27



Art. 4640

Coppia ruote per porte trasportabili ridotte Art. 114-T, 118-G, 116-TDV, 120-TG
Pair of wheels for reduced size transportable goals Art. 114-T, 118-G, 116-TDV, 120-TG



Le porte ridotte sono disponibili anche nel modello fisso con pali e bossole da interrare
Available also fixed models with underground sockets



Art. 119G
Art. 120-G

Scegliere reti con profondità posteriore bassa cm. 160
Pick nets with depth 160 cm. at ground level



Art. 240RU



Art. 240AF



Art. 241C

pg.26

Art. 119G Coppia Porte m. 5 x 2 a traversa divisa in acciaio trasportabili tubo 80 mm.
Pair of Goals m. 5 x 2 crossbar in 2 pieces in painted steel, transportable, pipe 80 mm.

Art. 120-G Coppia Porte m. 6 x 2 a traversa divisa in acciaio trasportabili tubo sezione 80 mm.
Pair of Goals m. 6 x 2 crossbars in 2 pieces in painted steel, transportable pipe 80 mm.

Art. 240RU Coppia ruote gommare con staffa per porte Art. 119G/120-G Pair of wheels for transportable goals Art. 119G/120-G

Art. 240AF Kit di fissaggio a terra per porte Art. 119G/120-G Ground anchoring kit for transportable goals Art. 119G/120-G

Art. 241C Chiave per kit di fissaggio Art. 240AF Key for ground anchoring kit Art. 240AF

Art. 122G
Coppia Porte Calcetto trasportabili m. 3 x 2 in acciaio verniciato tubo sezione 80 mm.
Pair of Goals m. 3 x 2 transportable in painted steel pipe 80 mm.

pg.27

Art. 121G
Coppia Porte Calcetto trasportabili m. 3 x 2 in lega leggera tubo sezione 80 mm.
Pair of Goals m. 3 x 2 transportable in light alloy pipe 80 mm.



Art. 122G

Art. 121G

ATTENZIONE:
in caso di ordine errato da parte del Cliente le porte, una volta consegnate, non possono essere sostituite

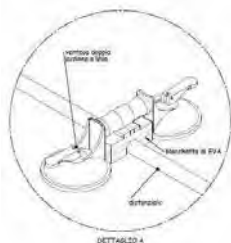

Art. VTCL
Ventosa doppia per ancoraggio a terra porte calcetto su superfici indoor lisce (si consigliano 2 kit per ciascuna porta)
Ground anchoring suckers for reduced goals to be used upon indoor smooth floors (it takes 2 kits for every goal)

pg.27



Art. DSSCE
Sacco zavorra vuoto (da riempire con sabbia) per ancoraggio porte trasportabili regolamentari e ridotte
Empty Ballast Bag (to be filled with sand) for goal anchoring



Art. DSS20
Sacco zavorra kg. 20 (riempito con sabbia) per ancoraggio porte trasportabili regolamentari e ridotte
Ballast Bag weight 20 Kg. for goal anchoring

Art. PC04
Picchetto in alluminio per ancoraggio a terra su terreno naturale di porte ridotte con distanziale sottile
Aluminium anchoring hook for reduced soccer goals with thin pipe ground bases

Art. AM01.7/.../AM01.3
TUBO ZAVORRA in PVC diametro 50 mm. atossico, flessibile, modellabile, appesantito da composto ecologico (peso 6 Kg. per metro) resistente alle alte e basse temperature e ai raggi ultravioletti per porte ridotte mt. 3x2/4x2/5x2/6x2 e regolamentari sia fisse che trasportabili
Weighted soft Pipe 50 mm. diameter (6 Kg. per meter) resistant to low temperatures and ultra violet rays for safe anchoring of transportable goals m. 3x2/4x2/5x2/6x2 and official size goals to the ground

pg.27





pg.27

Ideali per uso
privato
Not for official
matches

Art. SG176
Porta m. 3x2 trasportabile
in ferro verniciato,
tubo sezione mm. 32
completa di rete, ganci e
picchetti
3x2 meter transportable
Goal in painted iron, pipe
section 32 mm. complete
with net, hooks and pegs

**ATTENZIONE: in caso di ordine errato da parte del Cliente
le porte, una volta consegnate, non possono essere sostituite**

PORTE BIFRONTALI in lega leggera o acciaio dimensioni m. 3x2 - 4x2 - 6x2
Available 2 SIDE GOALS in light alloy or in painted steel dimensions m. 3 x 2 - 4 x 2 - 6 x 2

pg.27



Art. 084
Porta bifrontale
m. 4 x 2
in lega leggera
sezione tubo 50 mm.
completa di rete
Two Side Goal
4 x 2 m. in light alloy
pipe 50 mm.
net included

Art. 084AC
Porta bifrontale
m. 4 x 2
in acciaio verniciato
sezione tubo 50 mm.
completa di rete
Two Side Goal
4 x 2 m. in painted
steel, pipe 50 mm.
net included



pg.28



Art. IS215
Miniporta in acciaio m. 2,15 x 1,52 completa di rete, parete con bersagli e rete di rimbalzo
Steel Mini-goal m. 2,15 x 1,52 net, PVC target and rebounding net included

PORTE E MINIPORTE FLESSIBILI - Flexible goals and mini-goals



Art. FLEX1.5

Porta minicalcio m. 1,5 x 0,90 flessibile in vetroresina completa di rete e picchetti - peso Kg. 3,5 tempo di assemblaggio 1 minuto

Flexible fiberglass Mini-Goal size 1,5x0,9 mt. with net and pegs - weight 3,5 Kg. set up time 1 minute

pg.28



Art. S.BAGS

Coppia di sacchi zavorra da riempire con sabbia per l'ancoraggio delle porte Art. FLEX1.5 su terreni sintetici

Pair of sand bags (sand not included) for anchoring goals Art. FLEX1.5 on turf or synthetic grass

Art. FLEX.3

Porta calcetto m.3x2 flessibile con struttura in vetroresina, completa di rete e picchetti (non necessita dell'utilizzo di zavorre) peso Kg.12,5

tempo di assemblaggio 2 minuti

dimensioni imballo cm. 129x30x17

Flexible fiberglass Futsal Goal size 3x2 mt.

with net and pegs - weight 12,5 Kg. (sand bags not required) set up time 2 minutes



- Velocissime da assemblare
- I montanti in vetroresina flettono e tornano immediatamente in posizione al momento del goal o dell'impatto con la palla
- Facili da smontare e trasportare
- Leggerezza e minimo ingombro

- Quick set up
- Fiberglass poles flex and pop up straight after goal
- Easy to take down and carry
- Low weight and volume

pg.28



Art. FLEX7

Porta calcio regolamentare flessibile con struttura in vetroresina completa di rete e base di appoggio autoportante, utilizzabile sia su terreni naturali che sintetici peso Kg. 21 (non necessita dell'utilizzo di zavorre)

tempo di assemblaggio 3 minuti in 2 persone - dimensione imballo cm. 167x35x23

Flexible fiberglass official size Goal with net, ready for use on grass or turf (sand bags not required) Weight 21 Kg. - set up time 3 minute 2 people

MINI PORTE Mini-goals



Art. F214
Coppia Miniporte professionali
in acciaio verniciato tubo sezione 80 mm.
dimensioni m. 1,5 x 1 complete di reti
Pair of professional steel Mini-goals
pipe 80 mm. dimensions m. 1,5 x 1
nets included

pg.28



Art. F218
Coppia Miniporte professionali
in acciaio verniciato
tubo sezione 80 mm.
dimensioni cm. 90x60
complete di reti
Pair of professional steel Mini-goals
pipe 80 mm.
dimensions 90x60 cm.
nets included



Art. 123C
Coppia Miniporte in acciaio verniciato m. 1,5 x 1
complete di reti e picchetti
Pair of Mini-goals m. 1,5 x 1
in painted steel pegs and nets included



Art. 123F
Coppia Miniporte in acciaio verniciato
m. 1,5 x 1 complete di reti e picchetti
Pair of Mini-goals m. 1,5 x 1 in painted steel
pegs and nets included

pg.28



Art. 124C
Coppia Miniporte m. 1,5 x 1,1 in PVC rinforzato tubo Ø 70 mm. complete di reti e picchetti
Pair of PVC Mini-goals m. 1,5 x 1,1 pipe Ø 70 mm. pegs and nets included



Art. PUG
Coppia Miniporte in nylon
m. 1,83 x 1,07
complete di reti,
picchetti e borsa
Pair of nylon Mini-goals
1,83 x 1,07 m.
nets, pegs and bag included

pg.28

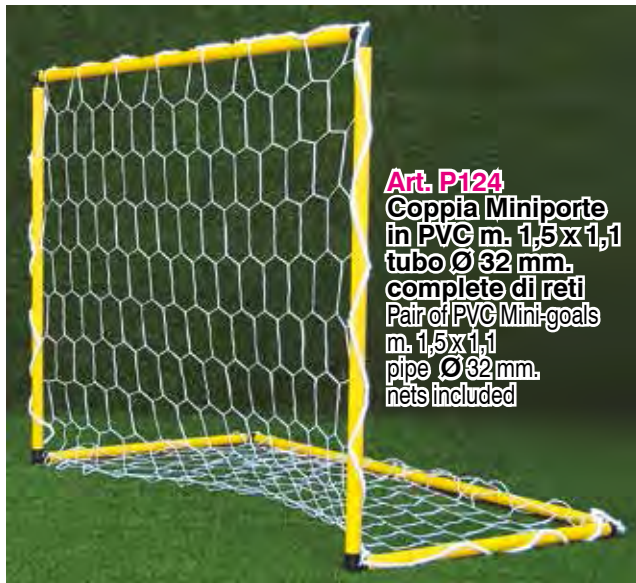

Art. P124
Coppia Miniporte
in PVC m. 1,5x1,1
tubo Ø 32 mm.
complete di reti
Pair of PVC Mini-goals
m. 1,5x1,1
pipe Ø 32 mm.
nets included

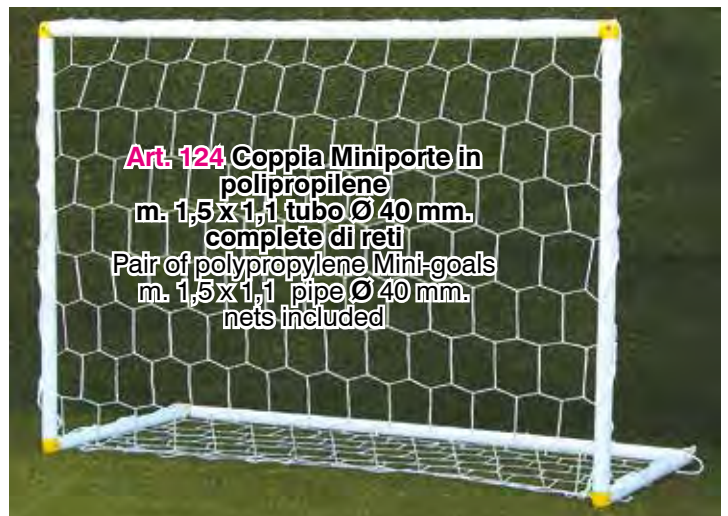

Art. 124 Coppia Miniporte in
polipropilene
m. 1,5x1,1 tubo Ø 40 mm.
complete di reti
Pair of polypropylene Mini-goals
m. 1,5x1,1 pipe Ø 40 mm.
nets included



pg.28

Dimensioni porte ribaltate
m. 1,5 x 0,80
Goal upside down
dimensions 1,5 x 0,80 m.



Art. A124
Coppia Miniporte in alluminio m. 1,5 x 1,1
tubo Ø 32 mm. complete di reti
Pair of aluminium Mini-goals m. 1,5 x 1,1
pipe Ø 32 mm. - nets included



Dimensioni Porta ribaltata m. 1,5 x 0,80
Goal upside down dimensions 1,5 x 0,80 m.

RETI REGOLAMENTARI - Regular Nets



***Le reti a maglia esagonale sono tessute, quelle a maglia quadrata sono annodate**

***Square mesh nets are knotted**



Art. 125E

polipropilene sp. mm. 3
profondità cm.170x170 depth

pg.28

pg.29



Art. 125

polipropilene sp. mm. 4
profondità cm.170x170 depth



Art. 126

poliestere sp. mm. 5
profondità cm.100x200 depth



Art. 127

polipropilene sp. mm. 5
profondità cm.200x200 depth



Art. B19

polietilene sp.mm.3,5
profondità
cm.100x200 depth



Art. 128E

polietilene sp.mm.3,5
profondità
cm.170x170 depth



Art. 128

polietilene sp.mm.4,5
profondità
cm.200x200 depth



Art. B011 polipropilene sp.mm.5
maglia mm.120 mesh
colori: bianco, rosso, verde, blu e nero white, red, green, blue or black
certificate FIGC/LND certified
profondità cm.200x200 depth



Art. 128FR Coppia reti annodate in polietilene sp.mm.4 bianche o a strisce colorate (bianco-royal, bianco-rosso, giallo-royal) profondità cm.100x200 depth
Pair of nets polyethylene 4 mm. color stripes, knotted (available in white, white-royal, yellow-royal, white-red)



Art. 128C Coppia reti annodate in polietilene sp.mm.3,5 a strisce colorate (bianco-royal, bianco-rosso, giallo-royal, rosso-blu, bianco-nero, bianco-verde) profondità cm.200x200 depth
Pair of nets polyethylene 3,5 mm. color stripes, knotted (available in white-royal, yellow-royal, white-red, white-black, white-green, red-blue)



Art. 129T
Coppia reti polipropilene sp. mm. 6 annodate a mano a strisce colorate (consigliabile per combinazioni di colori alternative a quelle degli Art.128FR e 128C) profondità cm.200x200 depth
Pair of nets with color stripes, hand knotted in various combinations

RETI RIDOTTE - Reduced Size Nets



Art. 131.5
Coppia Reti Pair of Nets
m. 6,50 x 2,50
Polipropilene sp. mm. 4

Art. 133
Coppia Reti Pair of Nets
m. 4 x 2
Polipropilene sp. mm. 4

Art. 133SN / 132N / 131N
Coppia Reti Pair of Nets
annodate
m. 4x2 - 5x2 - 6x2
knotted
polietilene sp. mm. 2,5

● pg.29



Art. 131.22 / B170 / B171
Coppia Reti Pair of Nets
annodate m. 6x2,20 - 6x2 - 5x2
knotted polietilene sp. mm. 3,5



Art. 133LR / 133NP
Coppia Reti Pair of Nets
annodate m. 4x2
knotted polietilene sp. mm. 3,5
prof. cm.100x100/cm.100x160 depth

RETI CALCETTO - Futsal Nets m. 3x2



Art. 134E
polietilene
annodate knotted
sp. mm. 2,5

● pg.29



Art. 135FR
polietilene **annodate** knotted
colori: bianco-royal, bianco-rosso, giallo-royal sp. mm. 3
colors: royal/white, red/white, yellow/royal



Art. 135C
polietilene **annodate** knotted
colore bianco sp. mm. 3,5
color white

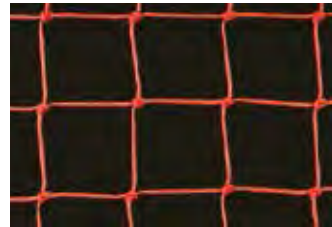

Art. 135
polietilene sp. mm. 4,5 **annodate** knotted
rosse, bianche o gialle
red, yellow or white



RETI PORTAPALLONI - Ball sacs



Art. 041-6 / 041-12 / 041-18 / S041-6 / S041-12 / S041-18
Reti Portapalloni in polipropilene
con o senza nodo
(da 6/12/18 palloni)
Nets for Balls
in polypropylene knotted or not
(6/12/18 balls)

● pg.29

● pg.30

Art. SM20
Sacca Portapalloni
in nylon 420/PVC
capienza 20 palloni
Ball Sac for 20 balls



RETI DI PROTEZIONE - Protection nets



*** TUTTE LE RETI DI PROTEZIONE VENGONO REALIZZATE SU MISURA IN BASE ALLE RICHIESTE DEL CLIENTE IN CIRCA 10 GIORNI**

*** All protection nets are manufactured according to Customer's needs in about 10 days**



● pg.30



Art. 093N
Rete protezione polietilene verde annodata
maglia cm. 13x13 sp. mm.2,5
per calcio e calcetto
Protection Net green polyet. mesh 13x13 cm.
knotted, thickness 2,5 mm.

Art. 093.5
Rete protezione polietilene verde
cm. 13x13 annodata sp. mm.3,5
per calcio e calcetto
Protection Net green polyethylene mesh
13x13 cm. knotted, thickness 3,5 mm.

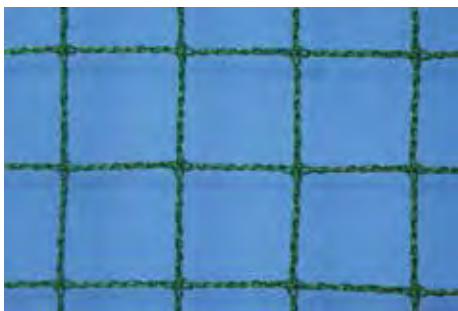

Art. 0934LR
Rete protezione
polietilene verde maglia
mm. 45x45 sp. mm.2
(per tennis e baseball)
Protection perimeter Net
for tennis and baseball

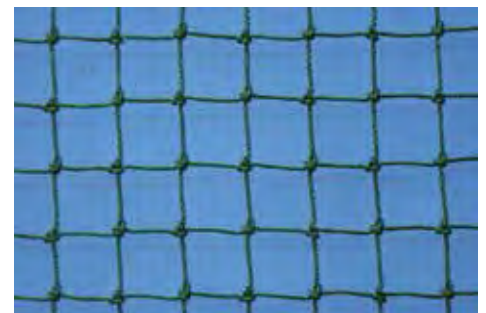

Art. R55
Rete protezione polietilene
nera maglia mm.18
annodata sp. mm.2
antioggetto / antipetardo
Protection Net
anti-objects and fire crackers

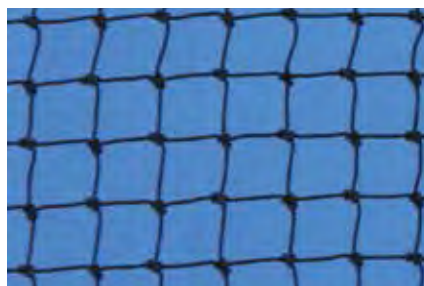

Art. R57
Rete protezione polietilene verde maglia
mm.25x25 sp. mm.3 (per golf)
Protection Net for golf

RETI PER CALCI DI PRECISIONE - Precision shooting nets

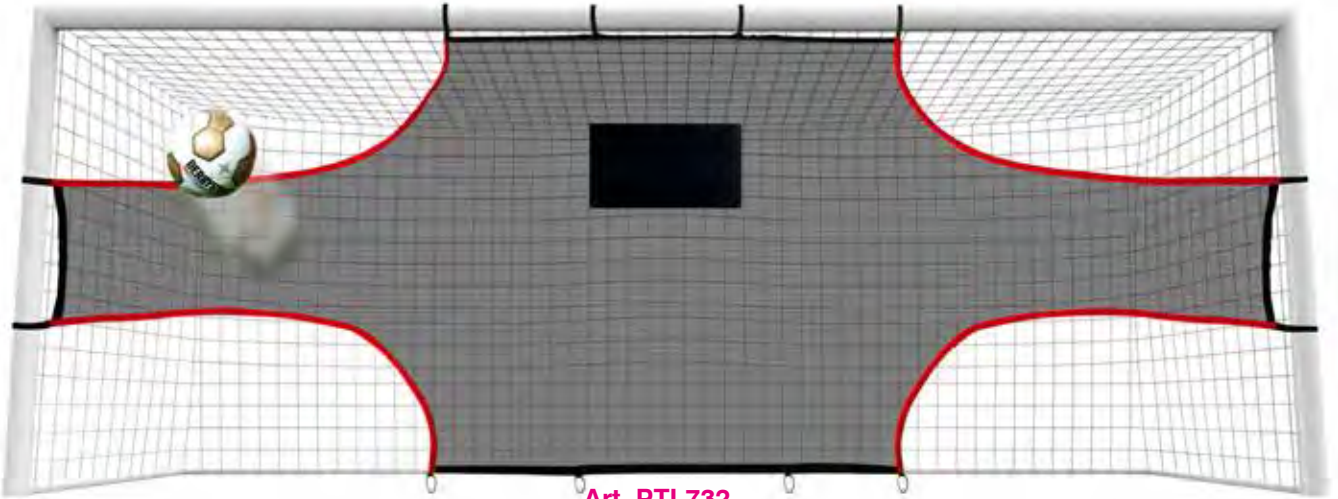

Art. PTI.732

Rete bersaglio per porta regolamentare completa di fasce con velcro per fissaggio a pali e traversa e picchetti per ancoraggio a terra
Target net for regular size goal complete with velcro straps for fixing to poles and crossbar and pegs for ground anchoring

New!

pg.29



4 tasche per calci di estrema precisione

Basta raccogliere palloni in fondo al sacco, lascia che sia la palla a tornare da te!

4 pockets for very accurate shootings

Stop picking up balls all the time, let the ball come back to you!

Art. GM

Rete respingente con 4 tasche per calci di precisione completa di corda elastica e picchetti da applicare a porta regolamentare
Special net with 4 accuracy pockets including elastic rope and pegs for regular size goal

Art. GM32

Rete respingente con 4 tasche per calci di precisione completa di corda elastica e picchetti da applicare a porta m. 3x2
Special net with 4 accuracy pockets including elastic rope and pegs for m. 3x2 goal

Art. QB5

Rete con bersagli sempre in piedi per allenamento alla precisione del tiro dei bambini delle scuole calcio
Net with 5 targets - always standing movable device to improve soccer school kids' precision shooting

La rete ha dimensioni cm.240x240 ed un peso di Kg.13 - facilmente spostabile sul campo, impossibile da abbattere a terra
Net dimensions 240x240 cm. weight 13 Kg. very easy to move on the field, never falls down when hit by ball

pg.7



PANCHINE ALLENATORI - Trainers' dug-outs



Panchina allenatori profilo curvato mm. 50x30 in acciaio zincato a caldo
Art. V6230 e seguenti
rivestimento posteriore in policarbonato alveolare non trasparente spessore mm. 4, fianchi rivestiti in policarbonato trasparente mm. 3, piano di seduta con scocche in polipropilene montate su telaio zincato

Altezza tettuccio cm. 200, profondità fianco laterale cm. 88

● pg.31

Panchina allenatori profilo curvato mm. 50x30 in acciaio zincato a caldo
Art. V6220 e seguenti
rivestimento posteriore e laterale in policarbonato trasparente spessore mm. 3, piano di seduta con scocche in polipropilene montate su telaio zincato



Art. V6285
Protezione in poliuretano espanso per bordo panchina allenatori con profilo mm. 50x30

Art. V6288
Coppia ruote da applicare a panchina con profilo mm. 50x30 al fine di renderla trasportabile





Art. 155AV/156AV/157AV/158AV/159AV/159.8AV/155AV4

Panchina allenatori con struttura in tubo quadro in lega d'alluminio mm. 30x30 con copertura in policarbonato alveolare non trasparente - fianchi laterali in policarbonato trasparente (2 scocche di seduta in polipropilene per ogni metro di lunghezza)

Dug-out in light alloy square pipe mm. 30x30 with non transparent alveolar protection
Transparent protection on both sides (2 polypropylene seats per every meter of length)

pg.32

*È possibile sostituire le scocche con le panche a listoni in legno con schienale senza variazioni di prezzo
Available wooden benches with back in spite of seats, at the same price*



*È necessario fissare le panchine su una base in cemento tramite tasselli: la base dovrà essere più estesa di circa 30 cm. per ciascun lato rispetto alla lunghezza e alla profondità della panchina.
It is necessary to anchor dug-outs upon concrete base. Size of concrete base must be about 60 cm. longer and deeper than dug-out perimetric size (30 cm. longer and wider on each of the 4 sides)*



Altezza tettuccio cm. 200 profondità fianco laterale cm. 74
Roof height 200 cm. - side depth 74 cm.



Art. 155/156/157/158/159/159.8/155-4

Panchina con struttura in tubo quadro in lega d'alluminio mm. 30x30 con copertura in policarbonato trasparente e scocche di seduta in polipropilene (2 scocche di seduta per ogni metro di lunghezza)
Dug-out in light alloy square pipe mm. 30x30 with transparent polycarbonate protection
(2 polypropylene seats per every meter of length)

pg.31

La verniciatura con colore a richiesta del tubo quadro in alluminio comporta una maggiorazione del prezzo del 10%
Optional painting of the square pipe frame in aluminium (color on request): 10% additional charge on selling price

È possibile sostituire le scocche con le panche a listoni in legno con schienale senza variazioni di prezzo
Available wooden benches with back in spite of seats, at the same price



Art. ASBI
Seduta ricambio per panchina allenatori
colore rosso o blu, fissaggio con 4 viti
Spare Seat for Dug-Outs in red or blue color, fixing with 4 screws

pg.32

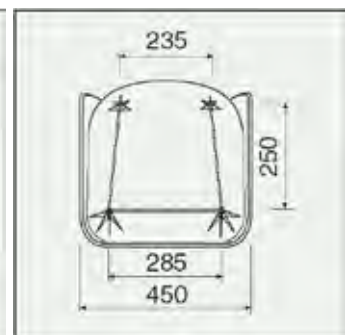
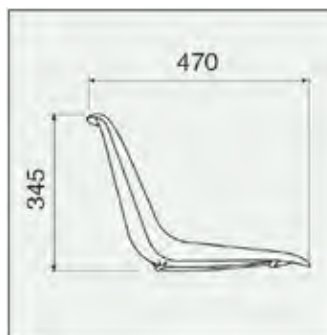

È necessario fissare le panchine su una base in cemento tramite tasselli: la base dovrà essere più estesa di circa 30 cm. per ciascun lato rispetto alla lunghezza e alla profondità della panchina
It is necessary to anchor dug-outs upon concrete base. Size of concrete base must be about 60 cm. longer and deeper than dug-out perimetric size (30 cm. longer and wider on each of the 4 sides)

PANCHINE LUSO - Luxury dug-outs



Art. 155FZ2/155FZ4/155FZ6/155FZ8

Panchina allenatori in acciaio zincato a caldo rinforzato profilo mm. 40x40 con profondità cm.180 (misurando da tettuccio a limite base posteriore di appoggio) rivestita con lastre in policarbonato trasparente spessore mm. 3 piano di seduta con scocche in polipropilene Mondo Seat 6

Dug-Out in galvanized steel pipe 40x40 mm. - 180 cm. depth (from back protection to edge of roof) transparent polycarbonate 3 mm. thick back cover - polypropylene seats on steel frame (2 seats each meter)



● pg.32

Art. 155PR

Rivestimento di protezione in schiumato per tettuccio e montanti
Soft edge protections



Art. LXR2/LXR4/LXR6/LXR8

Panchina allenatori in tubo di acciaio zincato a caldo profilo mm. 40x40 TRASPORTABILE su ruote - copertura in policarbonato trasparente profondità cm. 135 piano di seduta con scocche in polipropilene Mondo Seat 6

Dug-Out in galvanized steel pipe 40x40 mm. - TRANSPORTABLE on wheels transparent polycarbonate back cover polypropylene seats

PANCHINE ALLENATORI IDEALI PER CAMPI CALCETTO Trainers' dug-outs for futsal pitches



Panchina allenatori profilo curvato
mm 40x20 in lega di alluminio
rivestimento posteriore e laterale
in policarbonato alveolare sp. mm. 4
profondità a terra cm. 97,
altezza massima cm. 208
lunghezza metri 2 oppure metri 3
con panca sedute
in acciaio zincato e legno
Art. V6242.2 e Art. V6242.3
o con panca sedute
in alluminio anodizzato
(come raffigurato nelle immagini)
Art. V6241.2 e Art. V6241.3

● pg.33



Dug-out curved profile
40x20 mm. in light alloy
rear and side coverings
in non transparent polycarbonate
4 mm. thick
soil depth 97 cm.
maximum height 208 cm.
2 meters or 3 meters length
with wooden bench on
galvanized steel
Art V6242.2 and V6242.3
or with bench in
anodized aluminium
(as shown in pictures)
Art V6241.2 and V6241.3

PANCHINE ALLENATORI IDEALI PER CAMPI CALCETTO Trainers' dug-outs for futsal pitches



Panchina allenatori trasportabile su ruote, profilo curvato mm. 50x30 in lega di alluminio rivestimento posteriore e laterale in policarbonato alveolare sp. mm. 4 **Art. V6291** oppure in policarbonato trasparente sp. mm. 3 **Art. V6292** profondità a terra cm. 150, altezza utile cm. 210 lunghezza metri 3 con supporto sedute in acciaio zincato e 6 scocche in polipropilene con piano borse sul retro dei seggiolini

pg.33

Dug-out transportable on wheels curved profile 50x30 mm. in light alloy rear and side coverings in non transparent polycarbonate mm. 4 thick **Art V6291** or in transparent polycarbonate mm. 3 thick **Art V6292** depth on the ground 150 cm. useful height 210 cm. length 3 meters with galvanized steel seat support and 6 polypropylene seats with back space for bags



Art. S04910
Panchina bordo campo struttura in acciaio zincato lunghezza cm. 200 con 4 scocche di seduta in polipropilene colorato
4 Sideline seats on galvanized steel frame length 200 cm.

pg.45

PANCHINE LUSSO CON SEDUTE IN ECOPELLE - Leather seat dug-outs



**PREVENTIVO SU RICHIESTA
PRICES ON REQUEST**

**Modelli fissi o trasportabili
struttura in acciaio zincato
poltrone in ecopelle personalizzabili**
Fixed or transportable Dug-Outs
galvanized steel frame
customizable leather seats





Art. 146

Vernice Ecologica atossica per manti erbosi Linea Stadio
lt. 15 - Kg. 19 ad alto rendimento
Ecological Paint for grass 15 liters - 19 Kg.



Art. 146E

Vernice Ecologica atossica per manti erbosi Biancostadio lt. 17 - Kg. 19
Ecological Paint for grass 17 liters - 19 Kg.

pg.30



Art. NTESA

Rotolo Nastro adesivo mt. 50 - h. 5 cm.
vari colori per tracciatura righe su superfici sintetiche
Tape for bounds
50 meter - 5 cm. height

Art. SIFS

Fettuccia segnasettore in materiale sintetico impermeabile colore bianco o rosso
larghezza mm. 50 in rotoli da m. 25 (chiodi inclusi)
Sector line in waterproof synthetic fabric, width 50 mm. length 25 m. color white or red (pegs included)



pg.31

Art. 146BP

Vernice bianca o gialla per manti sintetici a bassa permanenza (1 settimana)
17 litri, da utilizzare preferibilmente con carrello a rulli
Paint for artificial grass white or yellow color, short durability (1 week) 17 liters



Art. 146LP

Vernice bianca o gialla per manti sintetici a lunga permanenza (3 mesi) 17 litri, da utilizzare solo con carrello a rulli
Paint for artificial grass white or yellow color, long durability (3 months) 17 liters



Art. ELP2/ELP4

Elasticone per divisione spazi h. cm. 2 oppure h. cm. 4
lunghezza mt. 20, completo di 2 moschettoni
Elastic bound 2 cm. height or 4 cm. height - length 20 meters - with 2 hooks



Art. NS200

Rotolo nastro stradale mt. 200 - bianco/rosso
Red/White Tape length 200 meters



pg.30

Art. PFIx Plifix

Picchetto di riferimento permanente con erba sintetica bianca o colorata, per agevolare la tracciatura delle righe dei campi di gioco o per delimitazione aree
Confezione da 25 pezzi utensile in plastica incluso
Plifix - permanent peg with artificial white or coloured grass to help tracing lines on the field or mark areas
25 pieces set includes also plastic planting device

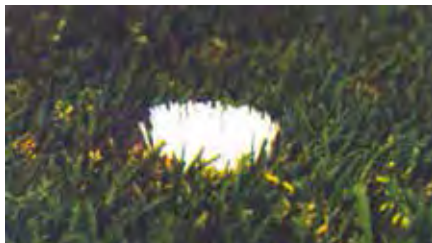

CARRELLI TRACCIALINEE - Line markers



pg.30

Per una resa ottimale
e per evitare inconvenienti
utilizzare sempre carbonato di calcio
asciutto, ovvero la comune
polvere di marmo

Art. 142S
**Carrello traccialinee
a polvere**
Marble Powder Line Marker

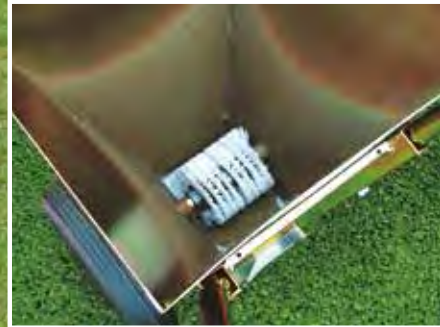

**UTILIZZARE SOLTANTO
VERNICE ECOLOGICA
ATOSSICA E PULIRE DOPO
OGNI USO IL
SERBATOIO E TUTTO IL
CIRCUITO DI SPRUZZO
FINO AGLI UGELLI**
(occorre spruzzare
ripetutamente acqua
prima di riporre l'attrezzo)
Always use ecological paint and
wash with water after use
(put water in the tank and spray)



Art. 144
**Carrello traccialinee
a vernice ecologica
con serbatoio munito di
pompa a pressione
manuale**
Paint Line Marker
with manual pressure tank

**Nuove ruote
antifango
in dotazione
new anti-mud
wheels**



pg.30

Particolare
leva pressione
spruzzo

Art. 145
**Carrello traccialinee
a vernice ecologica
con motore a scoppio
a miscela**
serbatoio vernice lt.25
tracciatura laterale regolabile
Paint Line Marker
with 2 stroke engine
25 liter tank



Art. 144.EL

Carrello traccialinee a vernice elettrico completo di caricabatteria (per la batteria della pompa elettrica) capacità serbatoio litri 18 tracciatura laterale regolabile

Electric Line Marker complete with battery charger 18 liter tank adjustable lateral marking device



Art. F211

Mirino in acciaio zincato per carrelli traccialinee Art. 144.EL ed Art. 145

Foresight in galvanized steel for line markers Art. 144.EL and Art. 145

pg.30

Art. 144.SL

Carrello traccialinee a rulli senza serbatoio a pressione né motore a scoppio. Tramite la rotazione dei rulli, la vernice viene prelevata all'interno del serbatoio e spalmata sull'erba.

Roller Paint Line Marker
Just fill up the tank with paint and push the machine.

Taking advantage of rolling wheels, paint flows from tank down to grass the easiest way!



SEDUTE PER GRADINATE - Stadium seats

COLORI DISPONIBILI: blu, rosso, giallo, verde, bianco, nero, grigio
AVAILABLE COLORS: blue, red, yellow, green, white, black, grey

pg.33

ORDINE MINIMO 10 PEZZI PER MODELLO E COLORE
Minimum quantity 10 pieces per model and color

**ATTENZIONE:
 NON PER PANCHINE
 ALLENATORI!
 NOT FOR TRAINERS'
 DUG-OUTS!**



Art. M2003

Art. M2003 Seduta in polipropilene con schienale ignifuga e antiultravioletti (secondo normativa UEFA) fissaggio diretto sulla gradinata con tasselli (non inclusi)
 Polypropylene Seat non ignitable and anti-ultraviolet rays with back rest (according to UEFA requirements) to be fixed with screws (not included)

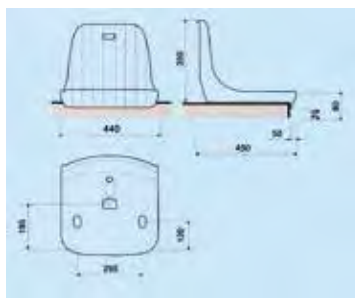
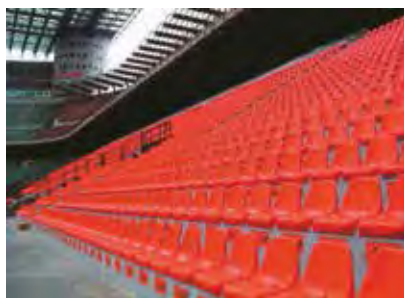

Art. M2003A Seduta in polipropilene antiultravioletti con schienale, fissaggio diretto sulla gradinata con tasselli (non inclusi)
 Polypropylene Seat anti-ultraviolet rays, with back rest to be fixed with screws (not included)

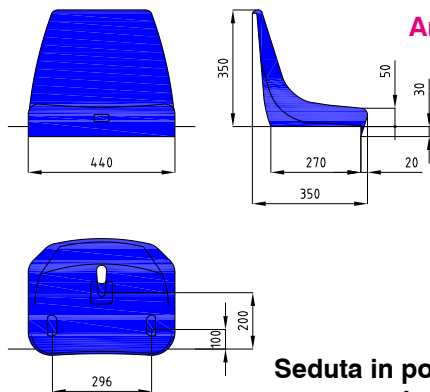

Art. M2008



Seduta in polipropilene con schienale ignifuga e antiultravioletti Art. M2008 oppure solo antiultravioletti Art. M2008A - fissaggio diretto sulla gradinata con tasselli (non inclusi)

Polypropylene Seat non ignitable and anti-ultraviolet rays **Art. M2008** or only anti-ultraviolet rays **Art. M2008A** with back rest to be fixed with screws (not included)

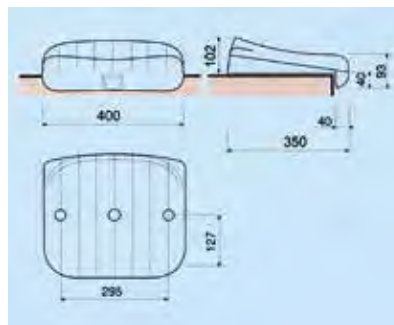
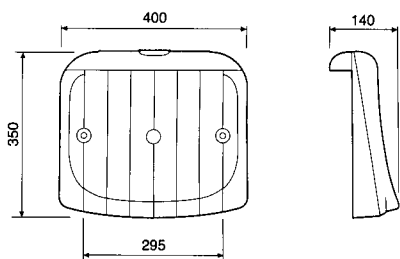

Art. M90

Art. M90

Seduta in polipropilene ignifuga e antiultravioletti - senza schienale fissaggio diretto sulla gradinata con tasselli (non inclusi)

Polypropylene Seat non ignitable and anti-ultraviolet rays, without back rest - to be fixed with screws (not included)

Art. M90.A

Seduta in polipropilene antiultravioletti - senza schienale fissaggio diretto sulla gradinata con tasselli (non inclusi)

Polypropylene Seat anti-ultraviolet rays, without back rest - to be fixed with screws (not included)

TRIBUNE - Stands



Art. G12005

Modulo Tribuna per interno/esterno su 3 file in acciaio zincato trasportabile su ruote, piani di seduta in carply, lunghezza m. 2,5
Indoor/outdoor Stand in galvanized steel, 3 rows, movable on wheels, with wooden benches



pg.34



Art. G12006

Modulo Tribuna per interno/esterno su 3 file in acciaio zincato trasportabile su ruote, piani di seduta con scocche in polipropilene, lunghezza m. 2,5
Indoor/outdoor Stand in galvanized steel, 3 rows, movable on wheels, with polypropylene seats



Art. G120TM
Tribuna telescopica da interno
con sedute in polipropilene
Telescopic Stand for indoor
with polypropylene seats

● pg.34



Art. CTMB1 ● pg.33
Cuscino per tribuna pieghevole
rivestito in nylon
colori blu o rosso, bordo nero
Foldable seat Cover - color blue or red



Art. S07700
Transenna in acciaio zincato
cm. 200x100h.
Galvanized steel barrier

● pg.34



Art. S07710
Transenna in plastica cm. 215x90h. con piedi di appoggio
a terra ruotabili, con banda catarifrangente e sistema di
aggancio a catena
Plastic barrier 215x90 cm.

ARREDI PER SPOGLIATOIO - Dressing Room Benches



Altre lunghezze disponibili: m. 1 e m. 1,5
Also available: length 1 and 1,5 meters

Profondità seduta cm. 35
altezza massima cm. 185
Depth 35 cm.
height 185 cm.



Art. S07310

Panca con schienale, appendiabiti e portaborse in acciaio verniciato con listoni in legno lunghezza m. 2

Complete Bench in painted steel and wood length m. 2

Art. S07320

Tavola attaccapanni con tettuccio lunghezza m. 2
Top side only in painted steel and wood length m. 2

Art. S07314
Panca completa doppia per centro stanza m. 2 in acciaio verniciato con listoni in legno
Double bench in painted steel and wood length m. 2

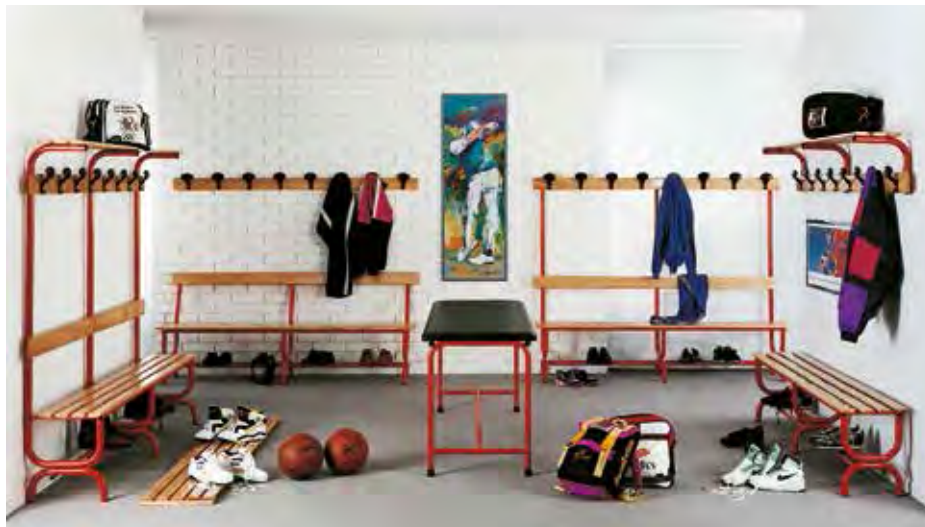

pg.34

ALTRI ARTICOLI SUL LISTINO PREZZI



Art. S07306

Panca in acciaio verniciato con listoni in legno m. 2 con schienale

Bench in painted steel and wood length m. 2 with back rest

Altre lunghezze disponibili: m. 1 e m. 1,5
Also available: length 1 and 1,5 meters



Art. S07302

Panca in acciaio verniciato con listoni in legno m. 2

Bench in painted steel and wood length m. 2

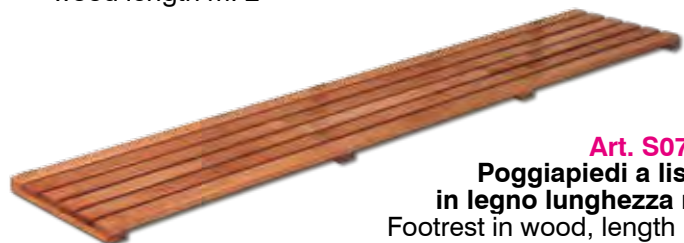

Art. S07404

Poggiapiedi a listoni in legno lunghezza m. 2
Footrest in wood, length m. 2



Art. V8626

**Profondità
seduta cm. 35
altezza massima cm.185
Depth 35 cm.
height 185 cm.**

Art. V8627

Art. V9093

Panca con schienale, appendiabiti e portaborse in alluminio anodizzato con inserti in PVC lunghezza m. 1 Art. V8626 oppure lunghezza m. 2 Art. V8627
Complete Bench in anodized aluminium length m. 1 **Art. V8626** or length m. 2 **Art. V8627**

Pedana poggiapiedi in alluminio anodizzato lunghezza m. 1 Art. V9092 oppure lunghezza m. 2 Art. V9093
Footrest in anodized aluminium length 1 or 2 meters

pg.34

pg.35

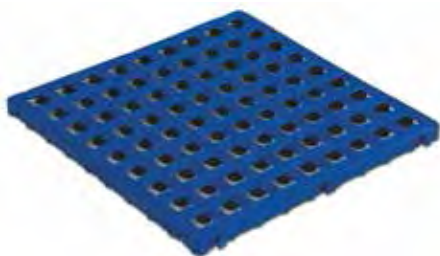

Art. S07408
Pedana poggiapiedi in plastica cm. 50x50
Plastic footrest 50x50cm.



Art. S07434
Graticcio per doccia in legno cm. 60x60
Wooden footrest 60x60cm.



Art. S07466
Asciugacapelli elettrico con temporizzatore e tubo flessibile
Hair dryer with timer and flexible pipe

Art. S07458
Asciugamani elettrico con temporizzatore
Hand dryer with timer



Art. TPD Poggiapiedi Footsy idrorepellente
Foldable foot rest waterproof



ALTRI ARTICOLI SUL LISTINO PREZZI

pg.35



Art. S07462
Asciugacapelli elettrico con temporizzatore
Hair dryer with timer

ARMADIETTI PER SPOGLIATOIO Dressing Room Lockers



Art. S07226
Armadio spogliatoio
a 15 posti in lamiera verniciata
dimensioni totali
overall dimensions
cm. 103Lx35px180h

pg.36



Art. MAP30
Armadio portavalori a 30 sportelli
dim. cm. 50hx95Lx20p con serrature
Safe-deposit locker with 30 boxes

Art. MAP50
Armadio portavalori a 50 sportelli
dim. cm. 82hx95Lx20p con serrature
Safe-deposit locker with 50 boxes



Art. S07252 / S07254 / S07256
Armadio spogliatoio in laminato
dim. vano cm.30Lx50px90h.
1 colonna 2 vani
2 colonne 4 vani
3 colonne 6 vani
Laminated Lockers

Art. S07258 / S07260 / S07262
Armadio spogliatoio in laminato
dim. vano cm.30Lx50px180h.
1 colonna 1 vano
2 colonne 2 vani
3 colonne 3 vani
Laminated Lockers

ACCESSORI PER SPOGLIATOIO E INFERMERIA Dressing room and infirmary accessories



Art. S07448
Specchio a parete
con cornice in plastica
diam.cm.60
Wall mirror with frame
diameter 60 cm.

Art. S07438
Distributore di sapone
liquido a parete
Wall soap dispenser



Art. S07442
Distributore di salviette a parete
Wall towel dispenser

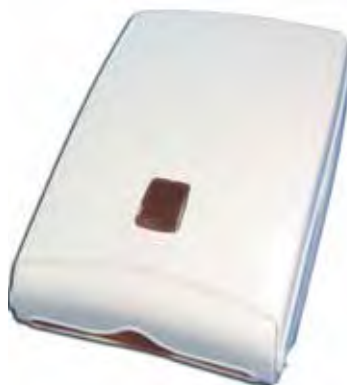

ALTRI ARTICOLI SUL
LISTINO PREZZI



Art. S07412
Tavolo per
spogliatoio e
locale arbitri
cm. 80x80x76
Locker room
table
80x80x76 cm.

pg.35



Art. S07416 Bacheca
con struttura in alluminio cm. 120x90
Bulletin Board

Art. S07414
Sedia in acciaio cromato
scocca in polipropilene
Chromed steel chair
with polypropylene seat



Art. S07418
Portaombrelli a 24 posti
in acciaio verniciato
Steel umbrella stand



Art. S07715 Spazzolone
per pulizia e asciugatura
area pubblica e campo di gioco
Scrubber for cleaning playground



Art. S07102 / S07104
Armadio a vetri a una o due ante
Glass Cabinet with one or two doors



Art. S07106 **Paravento a tre ante**
struttura in acciaio cromato
Three shutter foldable screen



Art. S07138
Cassetta medica secondo D.M. 388
First aid kit

ALTRI ARTICOLI SUL LISTINO PREZZI

pg.35 pg.36



Art. S07128
Scaletta scendiletto
in acciaio cromato
Bedside step



Art. S07124
Sgabello girevole
in alluminio
Turnable stool



Art. S07108
Appendiabiti a colonna
in acciaio cromato
Clothes stand



Art. S07132
Cestino in plastica
Plastic trashcan



Art. S07130
Portarifiuti
a pedale
in acciaio
verniciato
Metal trashcan



Art. S07134
Barella pieghevole
in acciaio cromato
Foldable Stretcher in
chromed steel

Art. S07110
Scrivania con cassettera
dim. cm.130x76x78
Desk with 3 drawers dimensions 130x76x78 cm.



pg.35

Art. S07114
Sedia imbottita, in acciaio cromato Chair in chromed steel



Art. S07410
Tavolo per massaggi in acciaio imbottito in similpelle
Massage table

pg.36

Art. PBN
Bilancia pesapersona con statimetro
Scales with height measurer



New!

Art. PTI.BIL
Bilancia pesapersona digitale con indicazione massa grassa
Digital scales body fat measurer



Art. 3031S
Lettino Antero chiudibile testiera regolabile
cm.180x60x73 peso Kg.20 colore nero in acciaio cromato
Medical couch foldable in chromed steel

Art. 3033S
Borsone porta lettino Antero
Bag for Art. 3031S

Art. S07118
Portarotolo
Paper roll holder

Art. S07120
Rotolo carta
Roll of paper



Art. S07116
Lettino visita medica imbottito con testiera reclinabile
Medical couch in chromed steel, padded, adjustable headrest

TUNNEL USCITA SPOGLIATOI - Stadium tunnels



Art. 160 Tunnel estensibile struttura in lega d'alluminio, copertura in PVC ignifugo Cl.2 bianca o colorata, montato su ruote in nylon, dimensioni standard (personalizzabili): larghezza cm.200, altezza al centro cm.235, in moduli da un metro

Extensible Tunnel in light alloy covered by fireproof PVC Cl.2, white or coloured, movable on nylon wheels - Standard dimensions 200 cm. width - 235 cm. height in the middle, made of 1 meter segments joined together



*** Lunghezza, larghezza
e altezza
personalizzabili su richiesta**
* Any dimension available
on request

BEACH SOCCER



Art. PBST Coppia Porte Beach Soccer m. 5,5x2,2 in lega d'alluminio, tubo sezione mm. 80 verniciate in giallo con bossole
Pair of Beach Soccer goals in aluminium 5,5x2,2 m. - pipe 80 mm. painted yellow with sockets

pg.28

Art. 110BS Coppia Porte Beach Soccer m. 5,5x2,2 in lega d'alluminio tubo sezione mm. 120x100 verniciate in giallo con bossole (senza innesti da cementare)
Pair of Beach Soccer goals in aluminium 5,5x2,2 m. - pipe 120x100 mm. painted yellow with sockets



Art. 073BS Kit 10 paletti completi per Beach Soccer (6 bandierine rosse e 4 bandierine gialle)
Beach Soccer Kit of 10 Poles (6 red flags and 4 yellow flags)



Art. RBS Coppia reti per porte Beach Soccer m. 5,5x2,2 in polipropilene
Pair of polypropylene nets for Beach Soccer goals 5,5x2,2 meters



Art. KDBS Kit Delimitazione per campo Beach Soccer, colore blu: 2 nastri m. 28 + 2 nastri m. 37 da mm. 80 + 8 picchetti e 8 elastici
Kit for Beach Soccer bounds



Art. M13615 Pallone Beach Soccer Mondo Copacabana
Mondo Beach Soccer Ball



Art. ULT45 Pallone Beach Soccer Trial in gomma doppio strato (fino ad esaurimento scorte)
Trial Beach Soccer Ball double stratum rubber (until available in stock)

TAVOLI CALCETTO - Soccer tables



Art. GA-F1
Tavolo calcetto
in legno modello F1
dim.cm.121x92x78h
aste telescopiche
ideale per bambini
Soccer table model F1
very good for children



Art. JKS300
Tavolo calcetto
senza gettoniera,
aste telescopiche,
piano in laminato plastico,
peso kg. 66
Soccer table JKS300
telescopic, weight 66 Kg.



Art. IS432
Confezione 10 palline per
tavolo calcetto
10 Soccer table balls

pg.47



Art. JKS400
Tavolo calcetto
senza gettoniera,
aste telescopiche,
piano in vetro temperato,
peso kg. 67,5
Soccer table JKS400
telescopic, weight 67,5 Kg.



Modello Pride

Art. FTGO.G
Tavolo calcetto modello Pride con
gettoniera, aste cromate telescopiche,
gambe in ferro verniciato, piano in
multistrato, peso kg. 73
Soccer table model Pride with coin slot
telescopic, legs in painted steel, weight
73 Kg.

Art. FTEC
Tavolo calcetto modello Pride
con vetro protettivo
ad alta resistenza, peso kg. 85
Model Pride with high resistance safety
glass, weight 85 kg.

Da esterno



Art. MPW
Tavolo calcetto da esterno
Master Pro Weatherproof
aste rientranti, gambe pieghevoli
Soccer table for outdoor

BASKET



Art. 0873
Impianto basket monotubolare zincato con sbalzo mt. 2,20 completo di tabelloni in resina melaminica, canestri e retine
 Basketball monotubular system galvanized with boards for outdoor



Art. BG2235
Coppia protezioni imbottite per impianto basket monotubolare h. cm. 200
 Pair of soft protections for Art. 0873



Art. V4248
Impianto basket monotubolare trasportabile tabelloni in legno sbalzo cm.165 canestri e retine
 Monotubular transportable basketball system

Art. V4500
Impianto basket come Art. V4248 zincato e con tabelloni in resina melaminica
 Monotubular transportable galvanized basketball system boards in resin for outdoor



Art. V4267
Set protezioni con pannello in legno rivestito in PE sp. mm. 20
 Pair of soft protections for Art. V4248

pg.36



Art.0857/0862/0858/0863
Impianto basket a traliccio zincato, sbalzo mt.2,20 fisso o mobile su ruote completo di contenitori in bilaminato o in resina melaminica, canestri e retine
 Basketball system in galvanized steel, with wooden or outdoor boards, fixed or transportable models

Art. B2084
Coppia protezioni imbottite per impianto basket a traliccio dim. cm.200x130
 Pair of soft protections for basketball system dimension 200x130 cm.



Art. S04056 / S04058
Impianto basket a muro fisso con sbalzo cm. 185 oppure cm. 325, tabelloni in bilaminato, canestri e retine
 Wall basketball system projection 185 or 325 cm. wooden boards, rings and nets



Art. S04151
Impianto minibasket a muro fisso, sbalzo cm. 80, tabelloni in bilaminato canestri e retine
 Wall mini-basketball system projection 80 cm.



Art. S04152
Impianto minibasket a muro fisso, sbalzo cm. 185 tabelloni in bilaminato canestri e retine
 Wall mini-basketball system projection 185 cm.

pg.36

pg.37



Art. S04150
Impianto basket/minibasket a muro regolabile in altezza con canestro e retina
 Wall basketball/mini-basketball system adjustable height



Art. 0986
Impianto minibasket fisso a colonna zincato altezza regolabile tabellone in plastica canestro e retina
 Mini-basketball system galvanized steel post, adjustable height, plastic backboard, ring and net

Art. S04161
Coppia strutture minibasket agganciabili a tabelloni basket complete di tabelloni in bilaminato, canestri e retine (attrezzo per sollevamento tabelloni Art. S04162 non incluso)
 Pair or mini-basketball constructions to be attached to basketball backboards (rising tool Art. S04162 not included)



Art. S04162



Art. 0987
Impianto minibasket a colonna regolabile in altezza e trasportabile, fornito con canestri e retine
 Transportable mini-basket system

pg.37

Art. S04012
Struttura basket e minibasket richiudibile e trasportabile in acciaio verniciato, base porta zavorra, tabellone in resina, canestro fisso e retina, protezione frontale
 Transportable and foldable Basket/Minibasket in painted steel, resin board, front protection



Art. 45097
Micro tabellone con palla
 Wall micro board with ball



Art. 647B Minibasket a colonna regolabile in altezza da cm. 168 a cm. 229 trasportabile, con canestro e retina tabellone cm. 90x60
 Minibasket adjustable height from 168 cm. to 229 cm. transportable



Art. 26760
Tabellone minibasket da fissare al muro, fornito con canestro e retina
 Wall minibasket board



Art. 26759
Basket a colonna regolabile in altezza da cm. 229 a cm. 305 trasportabile, con canestro e retina tabellone cm.120x70 - rinforzato
 Basket adjustable height from 229 cm. to 305 cm. transportable



Art. PPV01
Protezione monotubolare singola in nylon idrorepellente con velcro cm. 180x9x2 per Art. 647B e Art. 26759
 Single monotubular soft protection for Art. 647B and Art. 26759



Art. F102
Canestro Basket regolamentare
 (retina esclusa)
 Basket standard



Art. F103
Canestro Basket rinforzato
 (retina esclusa)
 Basket reinforced



Art. F105
Canestro Basket zincato
 (retina esclusa)
 Basket galvanized



Art. B030
Coppia Retine in nylon
 mm. 3,5
 Pair of nets 3,5 mm.



Art. B050
Coppia Retine in nylon
 mm. 6
 Pair of nets 6 mm.



Art. B060
Coppia Retine in cotone
 mm. 7
 Pair of nets 7 mm.



Art. R122
Coppia Retine in acciaio
 Pair of steel nets



Art. F106
Canestro Basket reclinabile, a norme FIBA
 (retina esclusa)
 Reclining Basket



Art. S04236
Canestro Basket reclinabile, omologato a norme FIBA (retina esclusa)
 Approved reclining Basket

pg.37

Art. NRGC
Set 12 ganci reggirete in plastica per canestro basket
 Set 12 plastic basket net holders

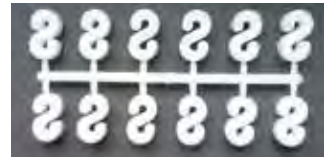

Art. S04202 - S04214 - S04204 - F116/B - S04216
Coppia tabelloni in bilaminato per interno oppure in resina melaminica per esterno - varie dimensioni
 Pair of basketball boards in chipboard for indoor or in resin for outdoor - various sizes

Brevettato
Patented

Art. F109
Canestro Basket reclinabile frontalmente e lateralmente (retina esclusa)
 Front/Side reclining Basket



Art. S04206 / S04208
Coppia tabelloni in Plexiglass trasparente oppure cristallo temperato dimensioni cm. 180 x 105 - compreso telaio e protezione
 Pair of basketball boards in transparent acrylic or tempered glass 180 x 105 cm. mounted onto varnished steel frame with pads

Art. B2063B / B2063
Coppia Protezioni sottocanestro omologate FIBA e non
 Pair of soft board protection pads FIBA approved or not



Art. S04254
Panca per atleti e riserve con poggiaschiena m.3
Bench length 3 meter with back rest

Art. S04266
Protezione mobile per tavolo giuria e atleti in policarbonato trasparente
Transparent movable polycarbonate protection for benches and referees' table



Art. S07518 pg.48
Elemento di separazione e protezione bordo campo cm. 200x50x75h.
in gomma espansa rivestita in PVC
Rubber bound for floor delimitation size 200x50x75h. cm.



Art. S04256
Tavolo giuria cm. 160x80x76h.
Referee table



Art. S04258
Tavolo giuria cm. 240x90x76h.
Referee table



Art. S04262
Tavolo giuria cm. 300x70x76h. carenato su ruote
Referee table on wheels



Art. S04288
Freccia indicatrice possesso palla
Ball possession arrow



Art. F255
Freccia indicatrice elettronica possesso palla
Electronic ball possession indicator



Art. F254
Segnalatore time out con impugnatura
Time out indicator



Art. CR016
Cronometro contasecondi da tavolo a pila con display digitale
Digital Table Clock for basketball



Art. CR005
Cronometro contasecondi da tavolo a pila con lancette
Table Clock for basketball



Art. S04280
Segnapunti
manuale
girevole
a 6 cifre
 6 figure
 Scoreboard



Art. B01084
Segnapunti da tavolo per Basket
 Table scoreboard



Art. S04274
Serie Palette 24"
 Set of 24 sec indicators



Art. S04272
Serie palette per giudici
 Set of referee's foul indicators

pg.38



Art. S04282
Segnapunti manuale a parete a 6 cifre, struttura in acciaio verniciato
 Wall steel 6 digit scoreboard

Art. 089-B
Lavagna Basket
cancellabile cm. 40x23
 Basket Tactical Board
 erasable 40x23 cm.

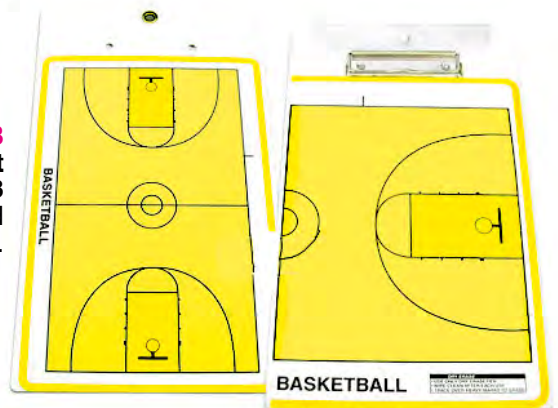

Art. 087-B
Lavagna Basket
magnetica
cancellabile
cm. 60x85
 Basket Tactical
 Board erasable
 and magnetic
 60x85 cm.



Art. LSRK
Lavagna Basket magnetica cm. 40x23
con block-notes
 Basket Tactical Board
 magnetic 40x23 cm. with block-notes



New!



Art. SK.CVS

Occhiali a visibilità limitata per allenamento al palleggio a testa alta, alla visione di gioco ed alla reattività nei confronti dei difensori misura unica regolabile

Court vision dribble goggles force players to handle the ball with their head up to survey the court improve reaction time against defenders increase confidence on the court



New!

Art. SK.KOT

KICK-OUT per ritorno palla dopo tiro a canestro - direzione regolabile

360° ball return system rotating chute returns made shots anywhere on the court easy twist adjustment with integrated handle



pg.38



New!

Art. KBVS

Kit braccia verticali per sagoma gonfiabile Art. SAG205
Raised arms kit for inflatable mannequin Art. SAG205

Specifico per il Basket, il kit si installa facilmente sulla sagoma (non inclusa) e rende possibile una moltitudine di esercizi tecnico-tattici
Designed for Basket training, this kit is easily installed on the dummy (not included) and makes lots of technical and tactical exercises possible

Art. SK.DMAN

Sagoma Basket ad altezza regolabile da cm. 198 a cm. 243 con basamento riempibile,

munita di puntali per fissaggio anche su terreni naturali
Hands-up defensive mannequin ideal for solo practice or team settings portable, lightweight adjustable telescoping pole (from 198 cm. to 243 cm.)
Weighted base - including spikes for natural grass anchoring



Art. MSBK4 Pallone avviamento al Minibasket Mondo gomma nylon misura 4
Minibasket introduction ball



Art. SB4Y Pallone avviamento al Minibasket Molten gomma nylon misura 4
Minibasket introduction ball



Art. M13565 Pallone Street Basket Mondo 3x3 misura 6
Mondo Street Basket ball 3 vs 3 - size 6



Art. B3002 Pallone Basket e Minibasket gomma nylon misure 5-7
Nylon rubber Basket and Minibasket ball



Art. SBPRO5 Pallone Minibasket Mondo SB-PRO n. 5 gomma multistrato
Multilayer rubber Minibasket Mondo SB-PRO 5 ball



Art. BGR5 Pallone Minibasket Molten BGR5 gomma nylon
Nylon rubber Minibasket Molten BGR5 ball

pg.38



Art. BGR7/BGR6 Pallone Basket Molten BGR7/BGR6 gomma nylon
Nylon rubber Basket Molten BGR7/BGR6 ball



Art. BGM7X/BGM6X Pallone Basket Molten BGM7X/BGM6X pelle sintetica FIBA Approved
Leather Basket Molten BGM7X/BGM6X ball

Art. BGF7X/BGF6X Pallone Basket Molten BGF7X/BGF6X pelle sintetica ufficiale FIP Serie B e C
Leather Basket Molten BGF7X/BGF6X ball



Art. BGG7X/BGG6X Pallone Basket Molten BGG7X/BGG6X pelle sintetica ufficiale FIP Serie A1 e A2
Leather Basket Molten BGG7X/BGG6X ball



Art. TRBB Pallone reaction ball Trial rimbalzo e traiettorie imprevedibili per Basket
Trial Reaction Ball unpredictable rebounds



Art. BYCB Pallone Basket bicolore gomma Trial Ø cm.24 - gr. 620
Trial bicoloured rubber Basket ball



Art. ULTS67 Pallone Basket gomma Trial allenamento potenziato Ø cm. 24 gr. 930 (+50%)
Rubber Trial Heavier Basket ball



Art. ULTD67 Pallone Basket gomma Trial allenamento potenziato Ø cm. 24 gr. 1240 (+100%)
Rubber Trial Heavier Basket ball

PALLAVOLO - Volleyball

Art. 6746T



Art. 6746T
Impianto pallavolo
monotubolare
in acciaio zincato
Ø 76 mm.
completo di bossole
da interrare cm. 40
e tendirete,
altezza della
rete regolabile
 Volleyball posts in
 galvanised steel with
 underground sockets
 adjustable height net

Disponibile anche
Also available

Art. V5003
Impianto pallavolo
monotubolare
in acciaio zincato Ø 70 mm.
completo di bossole
da interrare e tendirete
con sistema periscopico
per la regolazione
dell'altezza dei pali
e della rete
 Volleyball posts in
 galvanised steel with
 underground sockets
 periscopic posts
 adjustable height net

pg.40



Art. V5009



Art. V5009
Impianto
pallavolo
monotubolare
in alluminio T6
antiflessione
mm. 120x100
con arganello
tendirete
autofrenante
e senza
cremagliera
con manovella
asportabile - bossole
e tappi in alluminio
 Aluminium
 monotubular
 volleyball posts



Art. MB2083 Coppia
Protezioni in gommapiuma
rivestita per
impianto monotubolare
 Pair of soft protections
 for volleyball posts

IMPIANTO
= coppia pali
(rete esclusa)



Art. ARGC
Arganello a cremagliera
con maniglia per impianto
pallavolo monotubolare
 Spare rack winch for
 monotubular volleyball
 posts

Art. 6747/P
Impianto pallavolo
monotubolare a
norme FIPAV
in alluminio
sezione
mm. 120x100
regolazione
dell'altezza
dei pali e della rete
con sistema
periscopico
con arganello
tendirete
e bossole incluse
 Aluminium
 monotubular
 volleyball posts
 periscopic system
 FIPAV approved

La regolazione
periscopica permette di
variare l'altezza dei pali
oltre a quella della rete
(che può essere regolabile
da cm. 200 a cm. 250)

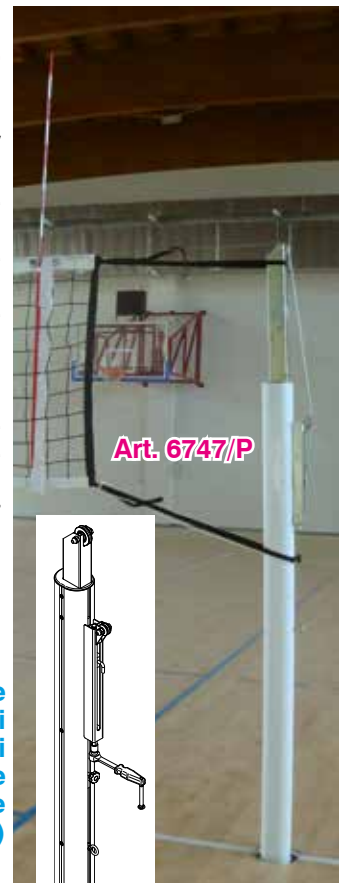

Art. 6747/P

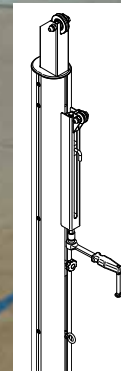



Art. 1009
Impianto pallavolo a traliccio in alluminio
 ø mm. 120x100 completo di ruote e tendirete
 Volleyball posts in aluminium transportable with wheels, pipe section 120x100 mm.



Art. MB2236
Coppia protezioni in gommapiuma rivestita per impianto a traliccio
 Pair of soft protections for volleyball posts



Art. 6740
Impianto pallavolo a traliccio ø mm. 70 in acciaio verniciato completo di tendirete
 Volleyball posts in painted steel pipe section 70 mm.



Art. V5020
Impianto pallavolo a traliccio ø mm. 70 in acciaio zincato completo di ruote e tendirete
 Volleyball posts in galvanized steel, transportable with wheels pipe section 70 mm.



Art. 6752/P
Coppia protezioni per impianto Pallavolo a parete
 Pair of soft protections for volleyball posts for wall fixing

Art. 6752/T
Impianto Pallavolo a parete
 Volleyball posts for wall fixing

pg.40

IMPIANTO = coppia pali (rete esclusa)

Art. V5029
Impianto pallavolo a tiranti ridotti in lega di alluminio profilo sezione mm. 120x100 con ruote per il trasporto piastra antitorsione alla base, arganello tendirete autofrenante senza cremagliera antinfortunistico
 Volleyball posts in aluminium transportable with wheels, pipe section 120x100 mm.





Art. P030
Rete pallavolo m. 9,50
 Net for volleyball



Art. P100
Rete pallavolo super pesante m. 9,50
 Heavy net for volleyball



Art. P110
Rete pallavolo extra pesante
m. 9,50 a doppia fascia
 Heavy net for volleyball double band

pg.41



Art. P200
Rete pallavolo da gara
con antenne e tasche
a norma FIPAV
 Official net for volleyball



Art. P14
Coppia antenne in vetroresina divise
 Fiberglass sticks in 2 pieces

Art. P15
Coppia bande verticali cm. 5
 Fixing bands for sticks

Art. P16
Coppia antenne in vetroresina intere
 One piece fiberglass sticks

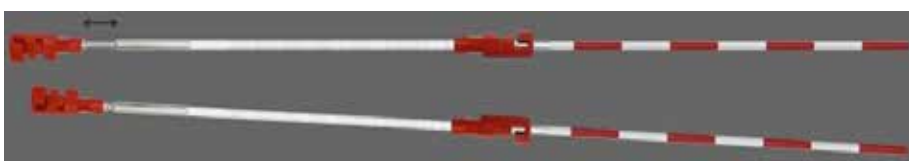

Art. P14PR
Coppia antenne in vetroresina divise professional
 Pro fiberglass sticks in 2 pieces

New!



Art. S04814
Segnapunti manuale girevole a 4 cifre
 4 figure scoreboard



Art. PP054
Segnapunti manuale da tavolo per Pallavolo bifacciale
(numeri da 0 a 50 non divisi)
 Volleyball table scoreboard



Art. PPP30
Segnapunti scolastico per Pallavolo numeri da 0 a 30 rinforzati
 Volleyball school scoreboard





Art. 6768R
Seggiolone arbitro pallavolo in piedi, in acciaio verniciato, mobile su ruote
 Referee's stand made of painted steel, on wheels

pg.41



Art. S04804
Seggiolone arbitro pallavolo ad altezza fissa con scocca di seduta, in acciaio verniciato, mobile su ruote
 Referee's stand fixed height with plastic seat, made of painted steel, on wheels



Art. 1020
Seggiolone arbitro pallavolo approvato FIPAV regolabile in altezza con scaletta di accesso e ruote per trasporto
 FIPAV Referee's chair



Art. VSRK
Lavagna per Pallavolo magnetica cancellabile con block-notes cm. 36x23
 Magnetic erasable Volleyball Tactical Board 36x23 cm.



Art. 089-V
Lavagna per Pallavolo cancellabile cm. 35x25
 Volleyball Tactical Board erasable cm. 35x25



Art. S04816
Serie 18 Palette per sostituzione giocatori con contenitore
 Set of 18 substitution indicators



Art. V5081
Simulatore di muro su ruote in acciaio, zavorrato, con pannello a superficie irregolare
 Portable wall in painted steel with irregular surface board



Art. V5082
Simulatore di muro portatile per squadre femminili e giovanili
 Portable wall for women and kids

pg.41



Art. P11032
Misuratore di elevazione da fissare a muro (misura l'elevazione da 1 a 3,40 metri)
 Wall jump meter in plastic (up to 340 cm.)



Art. V5051 **Jump Tester in acciaio zincato telescopico regolabile da cm. 230 a cm. 380 (basamento non incluso)**
 Jump Tester in painted steel telescopic adjustable height from 230 to 380 cm. (base not included)



Art. V5070
Ball Catcher cm. 70x70 altezza regolabile da cm. 190 a cm. 320 con anello superiore inclinabile, basamento e retone inclusi
 Ball catcher, adjustable height and inclination (base and net included)



Art. V5060 **Spike con ganasce (basamento non incluso)**
 (base not included)

Art. V5050
Basamento zavorrato multiuso per Ball Catcher, Spike, Jump Tester
 Multi-purpose weighted base





Art. BV20

Pallone Volley Trial in gomma supersoft
Supersoft Trial Volley ball



pg.41

pg.42



Art. V20

Pallone Volley Trial in gomma monostrato
Single stratum Trial Volley ball



Art. ULT20-3

Pallone Volley Trial in gomma triplo strato
Triple stratum Trial Volley ball

Art. MVBS

Pallone Volley School Mondo Under 13 peso ridotto
Under 13 Mondo Volley School ball

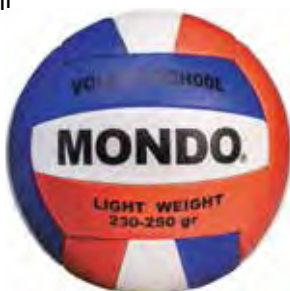

Art. E6835

Pallone Volley Soft Touch in PU saldato, regolamentare
Official size and weight Volley ball



Art. 18335

Pallone Volley School Molten V5M2501-L Under 13 peso ridotto
Under 13 Molten Volley School ball



Art. 29096

Pallone Volley Molten allenamento Ultra Touch V5M1500
Molten Volley training ball



Art. 6036

Pallone Volley Molten V5M4000



Art. 6331

Pallone Volley gara Molten V5M5000 "FLISTATEC" FIVB Approved



Art. BYCV

Pallone Volley Trial gomma bicolore
Trial bicoloured rubber Volley ball



Art. TRBV

Pallone Reaction Ball Trial doppio strato per Volley rimbalzo e traiettorie imprevedibili
Trial Volley ball for unpredictable rebounds



Art. MTVSC

Pallone Volley Molten Serve Cut



Art. USE20

Pallone Volley Trial gr. 405 (+50%) ø cm. 21 per allenamento potenziato
Rubber Trial heavier Volley ball



Art. ULTD20

Pallone Volley Trial gr. 540 (+100%) ø cm. 21 per allenamento potenziato
Rubber Trial heavier Volley ball



Art. ULT22

Pallone Volley Trial training con 2 elastici
Trial training Volley ball with 2 elastic ropes

MINIVOLLEY

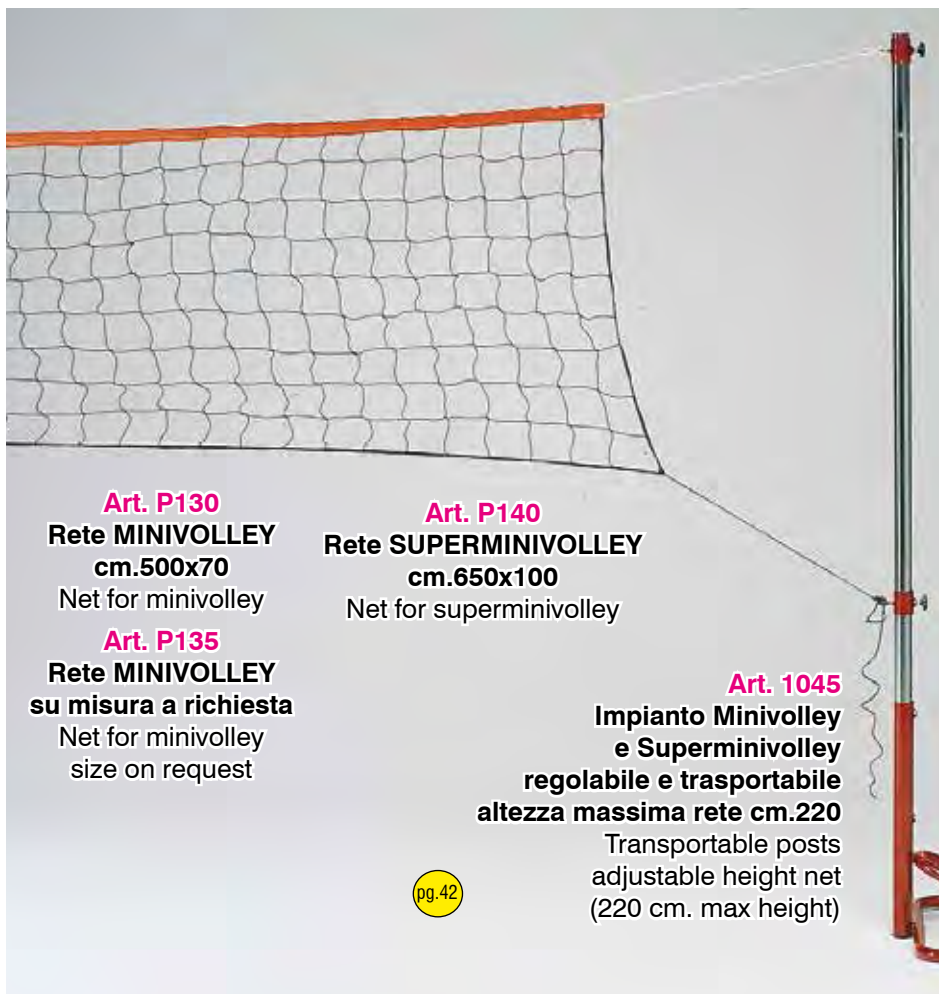

Art. P130
Rete MINIVOLLEY
cm.500x70
 Net for minivolley

Art. P135
Rete MINIVOLLEY
su misura a richiesta
 Net for minivolley
 size on request

Art. P140
Rete SUPERMINIVOLLEY
cm.650x100
 Net for superminivolley

Art. 1045
Impianto Minivolley
e Superminivolley
regolabile e trasportabile
altezza massima rete cm.220
 Transportable posts
 adjustable height net
 (220 cm. max height)

pg.42



Art. BV15
Pallone PRIMO VOLLEY
Trial in gomma supersoft
 Trial supersoft Volley ball



Art. ULT15-3
Pallone PRIMO VOLLEY
Trial in gomma triplo strato
 Trial triple stratum Volley ball



Art. 191S
Pallone
MINIVOLLEY
in gomma Mondo
 Mondo rubber
 Minivolley ball



Art. V33
Pallone
MINIVOLLEY
in gomma Trial
 Trial rubber
 Minivolley ball



Art. V27
Pallone
SUPERMINIVOLLEY
in gomma Trial
 Trial rubber
 Superminivolley ball



Art. MV210
Pallone MINIVOLLEY
"First Touch" Molten
nylon gr.210
(ad esaurimento)



Art. 6332
Pallone
MINIVOLLEY
in gomma Molten



Art. ULT26-3 / ULT27-3
Pallone MINIVOLLEY/
SUPERMINIVOLLEY
in gomma
triplo strato Trial

IMPIANTI MULTIFUNZIONE Multi-purpose systems



Art. S05206

Impianto multifunzione professionale per volley, minivolley, tennis e salto in alto - basi zavorrate in acciaio zincato su ruote gommate, ritti centimetrati in alluminio verniciato con cursore scorrevole

Volley, Minivolley, Tennis and High Jump transportable system - galvanized weighted bases with wheels, posts in painted aluminium with slider

Art. S05210

Rete per impianti multifunzione Art. S05202/S05204/S05206/PA020 dimensioni m. 9x1

Net for multi-purpose systems size m. 9x1



Art. 6780M

Impianto volley e minivolley trasportabile zavorrato
Weighted Volley and Minivolley transportable system

pg.40



Art. S05208

Coppia tabelloni in plastica con canestro su supporto in acciaio

per Art. S05206
Pair of Basket Boards with baskets and steel back frames for Art. S05206



Art. S05209

Set protezioni per impianto multifunzione Art. S05206

Soft Protection set for transportable system Art. S05206

pg.45

Art. S05202

Impianto multifunzione volley, minivolley, badminton, tennis trasportabile zavorrato strutture verticali in acciaio zincato e verniciato, con ruote
Volley, Minivolley, Badminton and Tennis transportable system



Art. S05204

Impianto multifunzione come Art. S05202 ma valido anche per basket (con tabelloni in plastica)

Same of Art. S05202 but also for basket (with plastic boards)

Art. PA020

Impianto multifunzione trasportabile completo di protezioni



Volley, Minivolley, Badminton and Beach Tennis transportable system



Altezza rete (non inclusa) regolabile da cm. 91 a cm. 245

Basi in ABS con ruote, riempibili con sabbia

BEACH VOLLEY

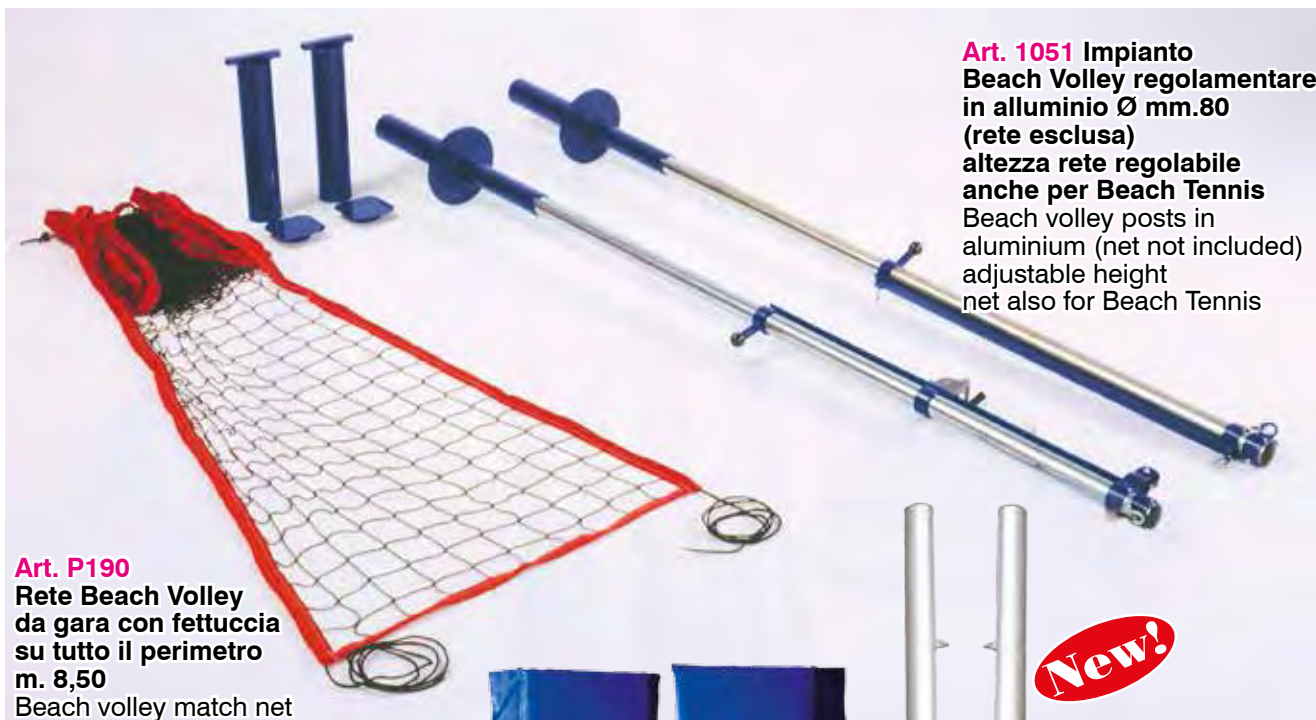

Art. P190
Rete Beach Volley
 da gara con fettuccia
 su tutto il perimetro
 m. 8,50
 Beach volley match net

Art. 1051 Impianto
 Beach Volley regolamentare
 in alluminio Ø mm.80
 (rete esclusa)
 altezza rete regolabile
 anche per Beach Tennis
 Beach volley posts in
 aluminium (net not included)
 adjustable height
 net also for Beach Tennis

pg.43



Art. P170
Rete Beach Volley m. 8,50
 con fettuccia sul lato superiore
 Beach volley net



Lato A Lato B

Art. BVMBP
Coppia protezioni
 per impianto Beach Volley
 regolamentare
 altezza cm. 200
 diametro cm. 8
 Pair of Beach Volley
 posts soft protections



Art. F501 Impianto Mini Beach Volley
 portatile con pali telescopici
 in ferro verniciato completo di rete
 mt. 6,5x1 e sacca
 Mini Beach Volley complete set



Art. F501

New!



Art. V5513
Impianto
 Beach Volley
 in alluminio
 (rete esclusa)
 senza bussole
 altezza rete
 regolabile
 anche per
 Beach Tennis
 Beach Volley
 posts
 in aluminium
 (net not
 included)
 with no sockets
 adjustable
 height net
 also for Beach
 Tennis

Art. V5510
Impianto Beach Volley
 in acciaio zincato
 (rete esclusa)
 altezza rete regolabile
 anche per Beach Tennis
 Beach Volley posts
 in galvanized steel
 (net not included)
 adjustable height net also
 for Beach Tennis



Art. V5543

Seggiolone per arbitro Beach Volley in acciaio ovale verniciato a polveri sez. mm.60 antinfortunistico e richiudibile in soli 45 cm. Beach Volley referee's Stand

Art. V5428

**Set imbottiture per seggiolone Art. V5543
Set of Soft Protections for Art. V5543**



Art. P17

Kit Delimitazione campo Beach Volley (2 nastri m.16 + 2 nastri m. 8 + 8 picchetti + 8 elastici) nastri da mm. 50 occhiellati alle estremità Set for Beach Volley Bounds



Art. P19 Kit Delimitazione regolabile per campo Beach Volley e Beach Tennis (2 nastri m.16 + 2 nastri m.8 oppure 2 nastri m.18 + 2 nastri m.9) colore blu Set for Beach Volley and Beach Tennis bounds adjustable blue color



Art. M13719

Pallone Beach Volley Mondo BV 2000 in pelle sintetica

pg.43



Art. 6340

Pallone Beach Volley da gara Molten BV5000 Pallone ufficiale FIVB



Art. 29097

Pallone Beach Volley Molten "Sweet Touch"

PROTEZIONI - Protections



Art. E6644

**Paio ginocchiere Volley trapuntate misura S, M, L
colori royal, nero, rosso, navy**
Pair of knee protections size S, M, L



Art. E6642

**Paio ginocchiere Volley gara misura JR e SR
colori royal, rosso e nero**
Pair of knee protections for match size JR and SR

pg. 42



***Art. 9293**
**Paradenti singolo
taglia adulto**
Adult Mouthguard

***Art. 9293.B**
**Paradenti singolo
taglia bambino**
Junior Mouthguard

***Disponibili
anche senza
reggi-paradenti**



Art. 43602A
**Paradenti doppio
taglia S-L**
Double Mouthguard Size S-L



Art. E6641

**Paio ginocchiere Volley
regolabili con velcro, misura SR colori blu e nero**
Pair of pro knee protections size SR adjustable with velcro - colors black and blue



Art. PDFOX
**Paradenti Fox singolo
taglia adulto - vari colori**
Adult Fox mouthguard - various colors



**Art. E6633 Paio gomitiere Volley, misura JR e SR
colori royal, rosso e nero**
Pair of elbow protections size JR and SR



Art. ESPN
**Maschera di
protezione per
naso, zigomi
e arcata
sopracciliare**
Face Protection
Mask



Art. 73001
**Sospensorio
con conchiglia,
misura S, M, L**
Shell Protection
size S, M, L



Art. E6649

Art. E6650

Art. E6670

Art. E6649

Paio ginocchiere elasticizzate misura S-M-L-XL
Pair of elastic Knee Protections size S-M-L-XL

Art. E6650

Paio cosciere elasticizzate misura S-M-L-XL
Pair of elastic Thigh Protections, size S-M-L-XL

Art. E6670

Paio cavigliere elasticizzate misura S-M-L-XL
colore nero o bianco
Pair of elastic Ankle Protections size S-M-L-XL
colors: black, white



Art. IS799
Ginocchiera
con supporti rigidi
taglia S/M - L/XL
Knee protection
with metal support



Art. E795
Ginocchiera in neoprene
taglia S-M-L-XL
Neoprene Knee Protection



Art. E798
Supporto Coscia
in neoprene
taglia S-M-L-XL
Neoprene Thigh
Protection



Art. E786
Cavigliera in neoprene
taglia S-M-L-XL
Neoprene Ankle Protection

pg.42



Art. 2651A
Short in neoprene
vita alta colore nero
taglia S-M-L-XL
Neoprene Shorts



Art. 90252A
Fascia sottorotulea in neoprene
Neoprene underknee band



Art. E796
Supporto gomito in neoprene
taglia unica regolabile
Neoprene Elbow Protection
one size fits all

Art. AHF-079
Panciera in neoprene
taglia unica 120x25x0,4 cm
Neoprene Stomach band
25 cm. height



PALLAMANO - Handball



Art. 1096
Coppia porte pallamano
in alluminio, reti escluse
Pair aluminium handball Goals

Le reti per porte pallamano
corrispondono alle reti
per porte calcetto m. 3x2
Same nets as futsal goals m. 3x2



Art. SH1
Pallone Pallamano Trial Micro/Midi
Handball per l'apprendimento
dei fondamentali
Trial Rubber Micro/Midi Handball
helps in learning the basics



Art. BA25/BA0/BA29/BA30
Pallone Pallamano
Trial in gomma supersoft
junior / femm.
Handball supersoft
junior / size 2 in rubber



Art. M525
Pallone Pallamano
Mondo in gomma
mis. 3
(ad esaurimento)
Handball size 3
Mondo in rubber
(until available)



Art. M13651/M13650
Pallone Pallamano
Mondo Golden
pelle sintetica
mis. 2 o mis. 3
Handball size 2 and 3
in synthetic leather

New!



Art. PTI.HB
Lavagna Pallamano
bifacciale cancellabile
cm. 35x22
Handball tactical board



Art. V29 / V30 / V49 / ULT49-3 / ULT30-3
ULT303.15 / ULT29-3 / ULT24-3
Pallone Pallamano in gomma
Trial (mono e triplo strato) mis. 0-1-1,5-2-3
Trial Handball in rubber (single and triple stratum)
size 0-1-1,5-2-3



pg.43 pg.44



Art. ULT34 / ULT35 / ULT36-3 / ULT37-3
Pallone Beach Handball in gomma Trial triplo strato
mis.00, 0, 2, 3
Trial Beach Handball in rubber size 00, 0, 2, 3



Art. ULTS29 / ULTD29
ULTS30 / ULTD30
ULTS49 / ULTD49
Pallone gomma Trial
potenziato
Ø 15/17/18,5 cm.
gr. 375/500/550/630/
700/750
(+50% / +100%)
Rubber Trial Heavier Handball



Art. TRBH
Pallone Reaction Ball Trial
doppio strato
rimbalzo e traiettorie imprevedibili
Trial Reaction Ball unpredictable
rebounds - for Handball



Art. BYCH
Pallone Pallamano
bicolore gomma Trial
Ø cm.18,5 gr.420
Trial bicoloured
Handball

TABELLONI ELETTRONICI BASKET, PALLAVOLO, MULTISPORT Electronic scoreboards for basketball, volleyball, multisport



Art. F160

pg.38

Tabellone portatile multisport da tavolo con tastiera di comando per BASKET, VOLLEY, CALCETTO, PALLANUOTO, PALLAMANO, KICK BOXING, PING PONG etc. punteggi da 0 a 199 per lato set/bonus/falli da 0 a 9 per lato cronometro massimo 99 minuti e 59 secondi periodi da 0 a 9 - altezza cifre cm.9 dim. cm. 55x35x9,5
Multisport Table Scoreboard (for BASKET, VOLLEY, FUTSAL, WATER POLO, HANDBALL, KICK BOXING, TABLE TENNIS)



Art. F345

Tabellone elettronico PLAY30-V con console solo tasti e m. 30 di cavo - dim. cm. 85x38x11 h. cifre cm. 17,4 - indicato per VOLLEY, CALCETTO, PING PONG, BADMINTON, SQUASH punteggi 0-199 per lato - set/bonus da 0 a 9 per lato - possesso/priorità/turno lato dx o sx Electronic Board with console, dim. cm. 85x38x11 cm. 17,4 cm. high figures

Art. F345D

Tabellone elettronico PLAY30-V con console dotata di display - Art. F345 with display console

Art. F345T

Tabellone elettronico PLAY30-V con console solo tasti e telecomando a infrarossi Art. F345 with remote control



Art. F351D

pg.39

Tabellone MULTISPORT PLAY30-C con console a display luminoso per BASKET, VOLLEY, CALCETTO, PALLAMANO etc. punteggi da 0 a 199 per lato - set/bonus/falli da 0 a 9 per lato - cronometro 99 minuti e 59 secondi altezza cifre punteggio cm.17,4 - altezza cifre cronometro cm.15 - segnalazione acustica di fine tempo dim. cm.75x59x10 - Peso Kg.12,4 cavo console 60 metri



Art. F300-14

Cronometro da esterno (minuti + secondi) dim. cm.166,5x59x15 - h. cifre cm. 45 con console
Timer for outdoor with console

pg.40



Art. F331T

Cronometro da interno (minuti + secondi) dim. cm.85x38x11 con telecomando a infrarossi
Timer for indoor with remote control



Art. F3045015

Tabellone MULTISPORT dimensioni cm.91x60x9,5
 peso Kg.10 - utilizzabile per BASKET, VOLLEY, CALCETTO
 altezza cifre cm.15 - visualizzazione di punteggi, cronometro,
 timeout, falli squadra, periodo, possesso palla.
 Console Art. F307-01 o Art. F308-01 non inclusa
 Electronic Board, dim. 91x60x9,5 cm.
 15 cm. high figures for various sport.
 Console Art. F307-01 or Art. F308-01 not included



Art. F307-01

Console 300 per Art. F3045015
 Display LCD - utilizzabile per
 collegamento via cavo
 dim. cm.28,5x10,5x8
 Console for Art. F3045015 with cable system



Art. F308-01

Console 700 per Art. F242,
 Art. F3045025 e Art. F3045015
 Display touchscreen - utilizzabile per
 collegamento sia via cavo che via radio
 dim. cm.24,5x17x8,5
 Console for Art. F242, Art. F3045025
 and Art. F3045015 with cable or radio system

pg.39



Art. F3045025

Tabellone segnapunti MULTISPORT
 Omologato FIBA livello 3
 (BASKET, VOLLEY, CALCETTO, PUGILATO, TENNIS,
 PING PONG, BADMINTON etc.)
 altezza cifre cm.25 distanza di leggibilità m.110
 peso Kg.22 - dimensioni cm.140x83x9
 da utilizzare con console Art. F308-01 (non inclusa)
 Electronic Board, dim. 140x83x9 cm.
 25 cm. high figures for various sport.
 Console Art. F308-01 not included



Art. F270

Kit indicatori elettronici 24 secondi
 (h. cifre cm.20) dim. cm.29,2x30,4x4,4 cadauno
 completo di centralina munita di tastiera
 visualizzazione del tempo di tiro e del timeout
 segnalatori acustici di fine tempo, un cavo m.20
 e un cavo m.40 in dotazione
 Kit 24 second indicators with console



Art. F242

Tabellone MULTISPORT FS-130
 dimensioni cm.200x180x9 - peso Kg.60
 costruito secondo le disposizioni FIBA
 utilizzabile per BASKET, VOLLEY, CALCETTO,
 PALLAMANO, HOCKEY, TENNIS etc.
 altezza cifre cm.30 tempo di gioco 99:59
 punteggi di squadra (da 0 a 199) - periodo (0 - 9)
 falli di squadra/set vinti (da 0 a 9) - bonus
 (1 punto luminoso per squadra)
 timeout (3 punti luminosi per squadra)
 possesso/servizio/turno: frecce indicatrici
 indicazione ultimo fallo avvenuto
 (numero di maglia del giocatore e numero del fallo)
 Console Art. F308-01 non inclusa
 Electronic Board, dim. 200x180x9 cm.
 30 cm. high figures for various sport
 Console Art. F308-01 not included

pg.39



pg.39

Art. F308-01

Console 700 per Art. F242,
Art. F3045025 e Art. F3045015
Display touchscreen - utilizzabile per
collegamento sia via cavo che via radio
dim. cm.24,5x17x8,5
 Console for Art. F242, Art. F3045025
 and Art. F3045015 with cable or radio system



Art. F258-1

Tabellone elettronico indicatore dei
24 secondi e tempo di gioco FS-24s-1
 dim. cm.70,5x60x11,5 h. cifre cm.14
 e cm.30 - da collegare con
 Art. F253-01, completo di cavo m.50
 per collegamento alla console
 Art. F308-01 - protetto contro gli urti
 della palla - **N.B. Per un impianto**
Basket completo occorrono
n. 2 Art. F253-01 + n. 2 Art. F258-1
 24 second indicator board

Art. F253-01

Kit cornice
luminosa e
centralina di
comando per
tabellone basket
Ledstrip cm.515
 Kit light frame
 and control unit
 for basketball
 backboard
 Ledstrip 515 cm.

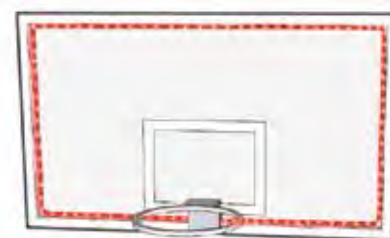

pg.40



Art. F265-20

Ricevitore radio per collegamento del
tabellone indicatore 24 secondi
Art. F258-1 alla console Art. F308-01
N.B. Per un impianto
Basket completo occorrono
n. 2 Art. F253-01 + n. 2 Art. F258-1
+ n. 2 Art. F265-20
 Radio receiver connecting
 Art. F258-1 to Art. F308-01



pg.40

Art. F300-26

Tabellone elettronico da esterno
ideale per CALCIO, CALCIO RIDOTTO E CALCETTO
 dim. cm.166,5x118x15 - altezza cifre 45cm.
Punteggio squadre da 0 a 9 - Cronometro 99:59
orologio - resistente agli urti della palla,
da utilizzare con console Art. F308-01 (non inclusa)
 Electronic scoreboard for outdoor - ideal for Soccer,
 Futsal - resistant to ball hits
 (console Art. F308-01 not included)

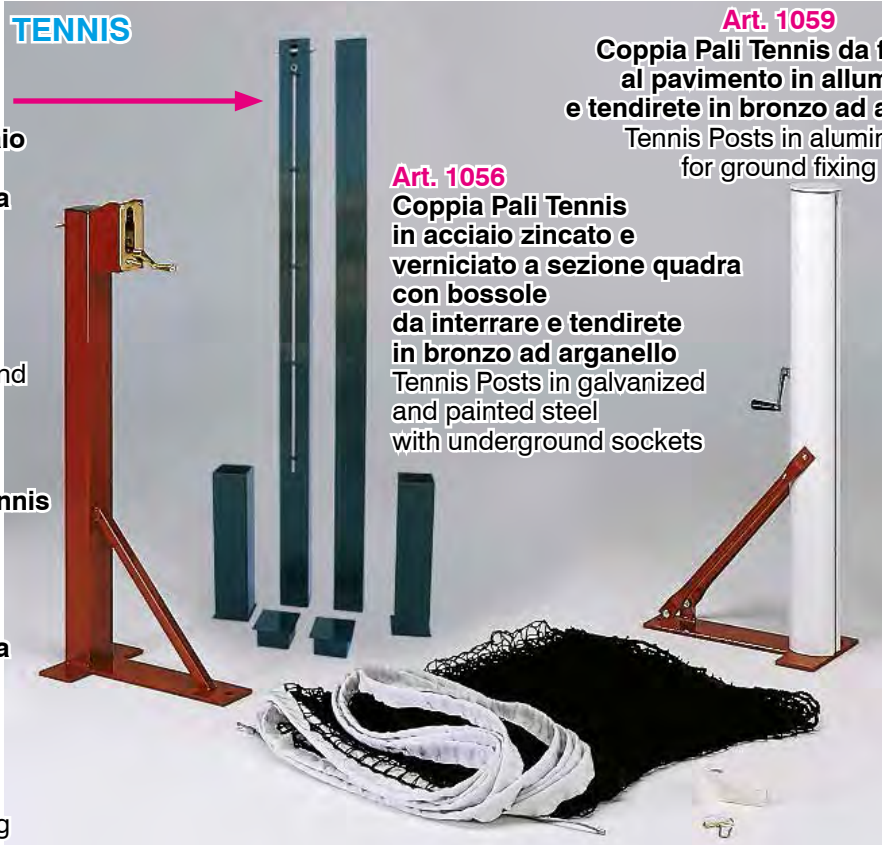

TENNIS

Art. 8820G
Coppia Pali Tennis in acciaio verniciato a sezione quadra con bossole da interrare e tendirete
Tennis Posts in painted steel with underground sockets

Art. 1058
Coppia Pali Tennis da fissare al pavimento in acciaio verniciato a sezione quadra e tendirete in bronzo ad arganello
Tennis Posts in painted steel for ground fixing

Art. 1059
Coppia Pali Tennis da fissare al pavimento in alluminio e tendirete in bronzo ad arganello
Tennis Posts in aluminium for ground fixing

Art. 1056
Coppia Pali Tennis in acciaio zincato e verniciato a sezione quadra con bossole da interrare e tendirete in bronzo ad arganello
Tennis Posts in galvanized and painted steel with underground sockets

pg.44

Art. 8819G
Coppia Pali Tennis in alluminio con bossole da interrare e tendirete
Tennis Posts in aluminium with underground sockets



Art. T030
Rete Tennis annodata m.12,80 x 1
Tennis knotted net



Art. T040
Rete Tennis da gara annodata modello Wimbledon m.12,80 x 1
Tennis knotted match net

Art. RT1
Centro rete
Net central holder



Art. G8835
Seggiolone verniciato per arbitro
Painted referee's Chair



Art. TE10031
Rete per impianto
Art. TE10030
Net for Art. TE10030
Art. TE10030
Impianto Junior Tennis cm. 500x100 in acciaio trasportabile (rete esclusa)
Transportable junior Tennis posts in steel (net not included)



Art. S04862
Impianto Tennis in acciaio zincato trasportabile (rete e zavorra escluse)
Transportable Tennis posts in galvanized steel (net and weights not included)



Art. S04868
Coppia paletti per singolo in acciaio verniciato
Pair of steel poles for single



Art. RTAD / RTB912 / RTB58
Racchetta Tennis Dunlop in lega
 23" (5/8 anni) - 25" (9/12 anni) - 27" (adulti)
 Tennis rackets



Art. 44.045
Over Grip



Art. E6620
Paio Polsini
tergisudore
 altezza cm. 7
 Pair of
 Wrist bands



Art. E6610
Fascia tergisudore
 altezza cm. 5
 Headband



Art. AGDP
Tubo 3 palle Tennis
depressurizzate Dunlop
 Set 3 depressurized
 Tennis balls



Art. T4D
Tubo 4 Palle Tennis
Head Championship
 Set 4 Tennis Balls

New!

pg.45



Art. 07861
Set 3 palline
gommapiuma
 Set 3 foam rubber
 Tennis balls



Art. 48018
Racchetta Beach Tennis in resina
(il colore ed il disegno possono variare)
 Beach Tennis racket

BEACH TENNIS



Art. PT41
Pallina Beach Tennis
 Beach Tennis ball

pg.44



Art. P210
Rete Beach Tennis
con fettuccia su tutto
il perimetro
 Beach Tennis net



Art. TE18002
Cesto contenitore e raccogli-palle con ruote
Basket for picking up Tennis balls



New!

Art. TE220.40
Macchina lancia palline
velocità max 130 km/h
velocità min 30 km/h
frequenza lancio da 2 a 15 secondi
Ball throwing machine



Art. TE51.04
Rullo in acciaio con racla
Levelling roller

pg.44



Art. RT3
Rotolo m. 150
strisce segnacampo
Tennis in PVC mm. 50
150 m. set
Tennis lines in PVC



Art. RT10
Stuoia livellatrice per campi in terra battuta m.2x1,5
Levelling net m.2x1,5

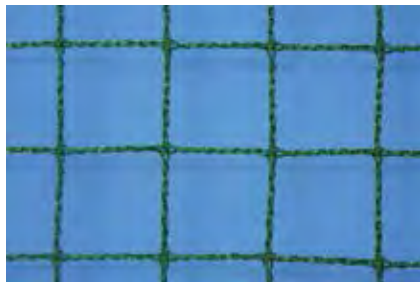

pg.45

Art. 0934LR
Rete protezione polietilene verde maglia cm. 4,5x4,5 sp. mm. 2
Protection Net green polyethylene mesh 4,5x4,5 cm. thick 2 mm.



Art. 40 - 40/S - 41 - 41/S
Telo fondo campo tennis densità 90% o 70% mt.18x2 con o senza banda di rinforzo
Tennis perimeter net density 90% or 70% dim. 18x2 meters



Art. TE53083
Tabellone segnapunti Tennis cm. 100x77 h. cifre cm. 12 completo di agganci per la recinzione
Tennis scoreboard 100x77 cm.

pg.45



Art. F166PST
Tabellone elettronico portatile da tavolo per Tennis
Portable Tennis electronic scoreboard

TENNIS TAVOLO - Table Tennis



Art. 568001
Racchetta
Ping Pong
Dunlop Nitro
Dunlop Nitro
table tennis bat



Art. 48439
Racchetta
Ping Pong
Expert
(ad esaurimento)
Expert table tennis bat
(until available)



Art. 83925A
Racchetta
Ping Pong
Dunlop
Blackstorm Spin
Dunlop
Blackstorm Spin
table tennis bat



Art. 48441
Confezione 6 Palline
Set of 6 table tennis balls



Art. 2C4118C
Confezione 100 Palline
1 stella colore bianco
Set of 100 table tennis balls



Art. 17362
Confezione 3 Palline
Stiga 3 stelle ITTF
Set of 3 Stiga table tennis balls

pg.46



Art. PP50
Rete in polietilene
Net



Art. E5019
Rete Ping Pong
regolabile portatile universale
Table tennis net adjustable length



Art. 48448
Set rete con paletti
Net with holder



Art. PPP30
Segnapunti per Ping Pong con numeri da 0 a 30 rinforzati
Table tennis scoreboard



Art. TEC.I
Tennis tavolo Tectonic indoor per interno
Indoor Table Tennis Tectonic

Art. TEC.O
Tennis tavolo Tectonic outdoor per esterno
Outdoor Table Tennis Tectonic



Art. C250.I
Tennis tavolo Cornilleau modello Sport 250 da interno
Indoor Table Tennis Cornilleau Sport 250

● pg.46



Art. C150S.O
Tennis tavolo Cornilleau modello 150S da esterno
Outdoor Table Tennis Cornilleau 150S



Tutti i tavoli sono pieghevoli e su ruote
All models are foldable and on wheels





Art. C400M.O
Tennis tavolo Cornilleau
modello 400M da esterno
Outdoor Table Tennis
Cornilleau 400M

pg.46



Art. C500.I
Tennis tavolo Cornilleau
modello 500 da interno
Indoor Table Tennis
Cornilleau 500



Art. C510.O
Tennis tavolo Cornilleau
modello 510 da esterno
Outdoor Table Tennis
Cornilleau 510

BADMINTON



Art. P160
Rete
Badminton
cm. 610x70
Badminton Net

V7700
Impianto Badminton
professionale in acciaio verniciato
zavorrato, su ruote, con tendirete
(rete esclusa)
Pro Badminton set (net not included)



Art. 23461
Racchetta Badminton
in acciaio/alluminio
Badminton Racket
in steel/aluminium

pg. 48



Art. PAC12
Racchetta Badminton
in grafite/alluminio
Badminton Racket
in graphite/aluminium



Art. 22309
Volano
Badminton
interamente
in plastica
Plastic
Shuttlecock

Art. AS85
Volano
Badminton
con capsula
in sughero
Cork tip
Shuttlecock



Art. JIN
Impianto
Mini Badminton
mt. 4,20x1,50
telescopico portatile
completo
di rete e borsa
Portable Mini
Badminton
set mt. 4,20x1,50
with net and bag

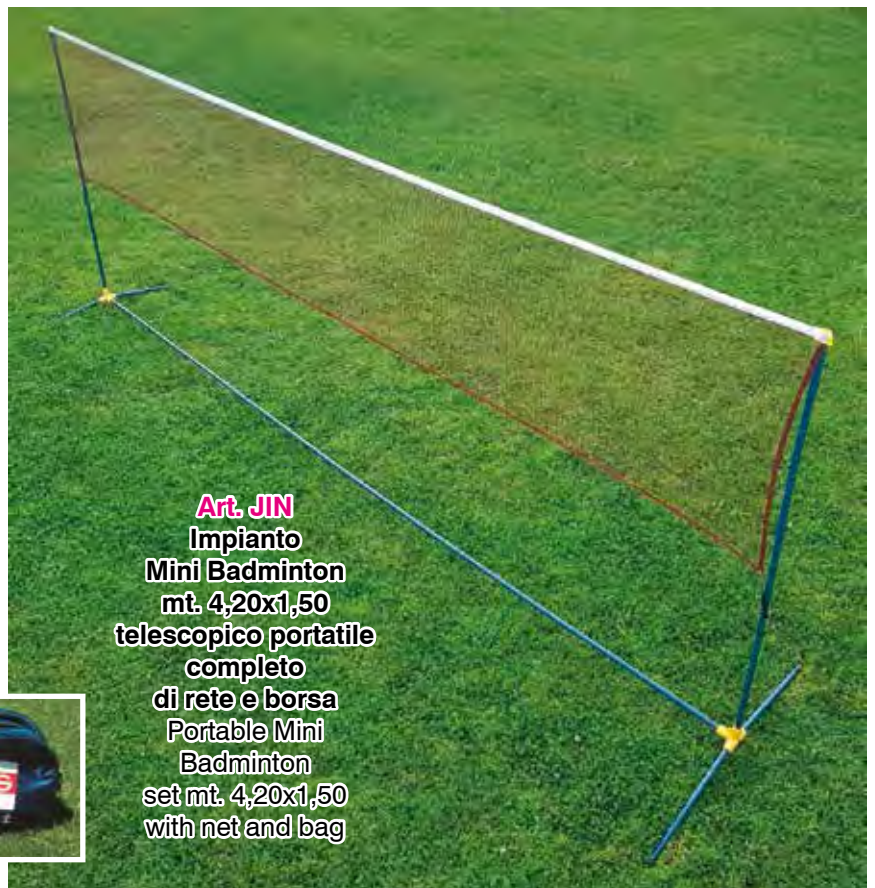

RUGBY



Art. 8836G1 / 8836G
Coppia Porte Rugby
in alluminio verniciato
m. 11 / m. 10 fuori terra
Rugby Goals
in painted aluminium



Art. 34721
Pallone rugby
in pelle sintetica
Rugby training ball
in synthetic leather

pg.47

pg.48



Art. V71
Pallone mini-rugby Trial
in gomma monostrato
gr. 350 dim. cm.15/27
Trial rubber mini-rugby Ball
single stratum



Art. F1645X
Pallone football americano
pelle sintetica - synthetic leather



Art. ULT71
Pallone mini-rugby Trial
in gomma doppio strato
gr.350 dim. cm.15/27
Trial rubber mini-rugby Ball
double stratum

Art. ULT70
Pallone rugby Trial
in gomma doppio strato
gr. 450 dim. cm.19/28
Trial rubber rugby Ball
double stratum



Art. 993164
Copri bandierina
cm.10x10x100 h.
Protection for rugby flag
pole, 10x10x100 cm.

Art. 6M18
Tacchetti rugby mm.18
in alluminio
Rugby aluminium
studs 18 mm.



Art. 993032
Scudo protezione
rugby cm.75x35x15
Rugby Shield

New!



Art. PTI.RU
Lavagna Rugby bifacciale
cancellabile cm. 35x22
Rugby tactical board
35x22 cm.



Art. PTI.FA
Lavagna per Football
Americano
bifacciale cancellabile
cm. 35x22
Football tactical board
35x22 cm.



Art. 993156/993157/993162
Protezione imbottita per
palo porta rugby
h. cm. 200, modello
quadrato oppure tondo
Soft Protection for rugby
goal post, square and round
shape, height 200 cm.



Art. 993151 / 993153JR
Sacco placcaggio rugby h. cm.140 o
cm.120 diam. cm. 45 o cm. 35,
con 3 maniglie
Sac for Tackling height 140 or 120 cm.
diameter 45 or 35 cm. with 3 handles

PISCINA - Swimming Pool



Art. E1901
Cuffia in poliestere
Polyester cap

pg.46



Art. E1904
Cuffia in lycra
Lycra cap



Art. E1127
Cuffia in silicone
Silicone cap



Art. E2607
Stringinaso con
cuscinetti in silicone
Silicone nose-clip



Art. E2608
Tappi auricolari in silicone
automodellanti - Set da 4 pz.
Silicone auricular plugs



Art. E2620
Occhialini
da piscina Junior
Junior glasses



Art. E2626
Occhialini
da piscina adulto antifog
monoscocca morbida
Senior antifog glasses



Art. E2618
Occhialini da piscina adulto antifog
monoscocca morbida
custodia con cerniera
Senior soft antifog glasses
case with zip



Art. E2641
Ostacolatore monoblocco
cm.15x22x7,5



Art. E2639
Tavoletta per piscina adulto
professionale cm.40x27
Senior professional board



Art. E2650
Paio palette palmari forate
cm.21x16 (misura S, M, L)



Art. E2660
Copriscarpe in PVC
set da 2000 pezzi - misura unica



Art. E2637/0
Paio manicotti arrotolabili
doppia valvola (3/6 anni)
Brackets



Art. E845
Paracadute per nuoto potenziato
Swimming parachute



Art. E848
Marsupio per nuoto potenziato
Swimming pouch



Art. E851
Elastico per nuoto trattenuto - mt. 12
Swimming elastic



Art. E483
Paio manubri per aquagym
cm.30 - diam. cm.14
Water aerobics dumb bells

pg.46

pg.47



Art. E482
Paio polsieri/cavigliere per aquagym
mis. cm. 62x11x2
Water aerobics wrist/ankle supports



Art. E474
Paio clavette per aquagym
Water aerobics clubs



Art. E484
Cintura per aquagym
cm.67x29x4
Water aerobics belt



Art. E479/3
Zattera in espanso forata
dim. cm.200x100x3
Pierced mat

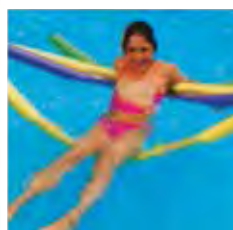

Art. E470
Cilindro in materiale espanso per aquagym
cm. 160 ø cm. 7
Water aerobics bar

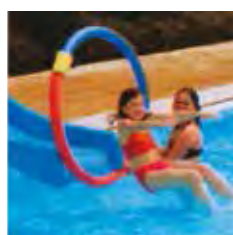

Art. E480/1
Connettore per cilindro
mis. cm.14 - 2 fori
Bar connector



Art. AQSA
Step per aquagym impilabile ad incastro
cm.70x35x19
Water aerobics step
cm.70x35x19

PALLANUOTO - Waterpolo

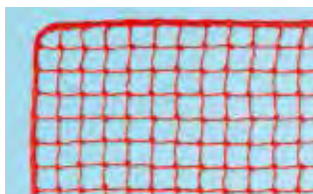
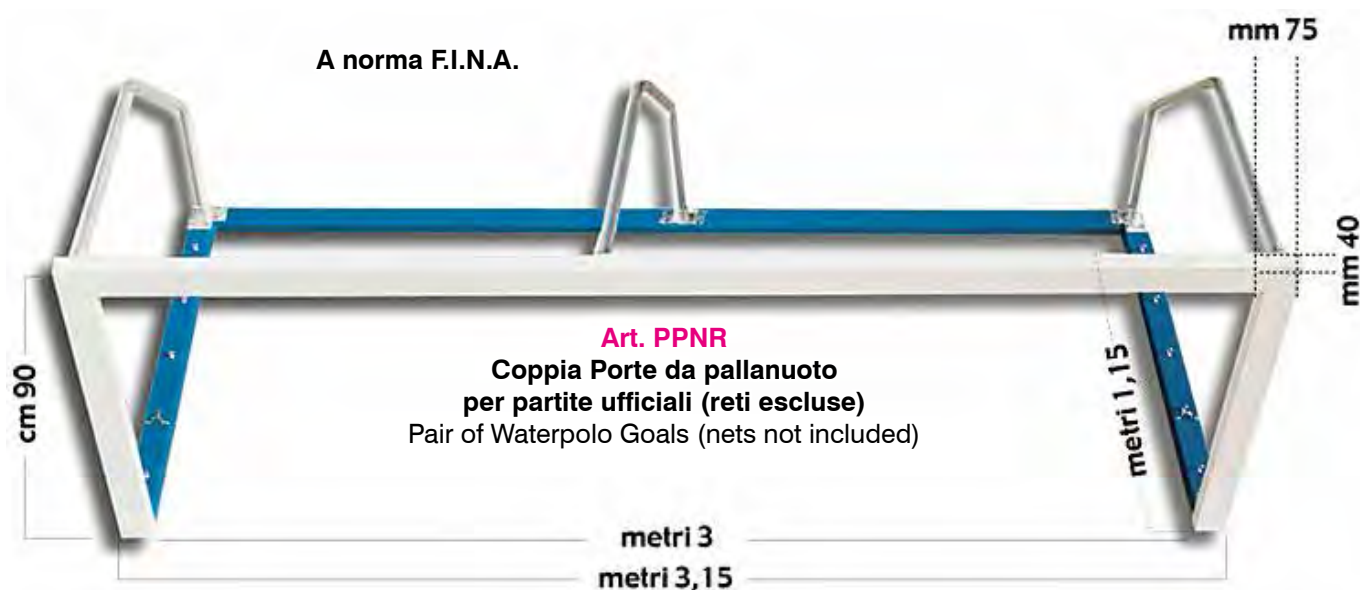

Art. 175P
Coppia reti per porte pallanuoto
Waterpolo Nets

pg.46



Art. AQPP
Coppia Miniporte da pallanuoto in PVC m. 1,5x0,8 complete di reti
Pair of Waterpolo PVC Mini-goals m. 1,5x0,8 nets included



Art. E80
Pallone pallanuoto Trial in Eva gr. 420 Ø 21 cm.
Waterpolo Trial ball in Eva



Art. E6890
Pallone pallanuoto
Waterpolo Ball



Art. 30415
Set cuffie pallanuoto colore bianco o blu con numero - set 14 pezzi
Waterpolo caps with numbers

HOCKEY



pg.47

Art. S05128

**Coppia porte per Hockey su pista
in acciaio verniciato**

Pair of Hockey Goals in painted steel

Art. S05122
**Coppia porte per Hockey su prato
in legno e acciaio verniciato**
Pair of Hockey Goals in wood
and painted steel



Art. PUH01
Pallina Unihockey
Unihockey ball



Art. S05134
**Set Unihockey composto
da 6+6 bastoni e 3 palline**

Set Unihockey made of 12 sticks and 3 balls

Art. H1
**Coppia RETI per porte da Hockey pista
(indoor) in polipropilene maglia mm.45
cm.300x200x100x100**

Pair of Track Hockey Goal nets

Art. H2
**Coppia RETI per porte da Hockey
ghiaccio in polipropilene complete di rete
di sbarramento, maglia
mm.20 - cm.193x122x75x120**
Pair of Ice Hockey Goal nets

Art. H3
**Coppia RETI per porte da Hockey
prato in polipropilene complete di rete
di sbarramento, maglia
mm.45 - cm.366x214x90x122**
Pair of Field Hockey Goal nets

Art. H4
**Coppia RETI per porte da Hockey rotelle in
polipropilene complete di rete di sbarramento,
maglia mm.20 - cm.185x122x74x110**
Pair of Roller Hockey Goal nets

BASEBALL



Art. TMB01
Mazza Baseball supersoft Trial
 lunghezza cm.71 diametro cm.4/5
 peso gr.460
 Supersoft Trial Baseball bat

pg.48



Art. S05152
Mazza Baseball regolamentare in legno
 Wooden Baseball bat

New!



Art. S05156
Palla Baseball rivestita in pelle sintetica
 Baseball ball



New!

Art. S05158
Guantone Baseball
 in pelle sintetica
 misura senior
 Senior Baseball glove

New!

Art. PTI.BB
Lavagna Baseball
 bifacciale cancellabile
 cm. 35x22
 Baseball tactical board
 35x22 cm.

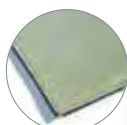

appoggio
 antiscivolo



imbottitura
 interna



Art. P21006
Set basi didattiche
 antiscivolo colorate
 Set of didactic anti-skid
 bases

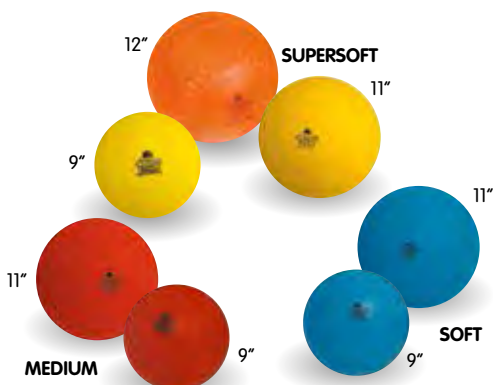

Art. BSB.8
Set 7 Palle Baseball/Softball
 Trial in gomma super soft
 diametri e grammature
 assortiti
 Set of Trial Baseball/Softball
 balls



Art. T21063
Batting tee Trial
 supersoft
 altezza regolabile
 da cm. 65 a cm. 86
 base diametro cm. 20,5
 peso Kg. 3
 Trial Batting tee
 adjustable height

ARTI MARZIALI - Martial Arts



Art. 24772
Divisa judo con cintura
misure da 000 (cm.110)
a 7 (cm.200)
Judo strip with belt

pg.56



Art. 24773
Divisa karate con cintura
misure da 00 (cm.120)
a 7 (cm.200)
Karate strip with belt



Art. 23271
Cintura judo/karate 100% cotone
colori: nero, blu, arancio, marrone, verde, giallo, rosso
misure da 1 a 7
Judo/Karate belt



Art. 23271.B
Cintura judo/karate 100% cotone
bicolore: bianco/giallo, giallo/arancio,
arancio/verde, verde/blu,
blu/marrone - misure da 1 a 7
Bicoloured Judo/Karate belt



Art. F163
Tabellone elettronico
portatile da tavolo
per Kick-Boxing
Kick-Boxing portable
electronic
Scoreboard



Art. F162
Tabellone elettronico portatile da
tavolo per Karate
Karate portable
electronic
Scoreboard

Art. F150
Fight Timer da parete
cm.56x19x4 - kg.1,6
Fight Timer



BOXE



Art. 992030
Sacco Boxe in vinile Kg.30
Vinyl boxing bag kg.30



Art. 992040
Sacco Boxe in vinile Kg.40
Vinyl boxing bag kg.40



Art. 992050
Sacco Boxe in vinile Kg.50
Vinyl boxing bag kg.50



Art. 993003
Gancio Ammortizzatore per sacco boxe
Spring for boxing bag

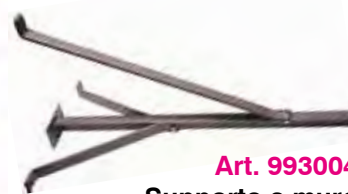

Art. 993004
Supporto a muro per sacco boxe
Iron wall support for boxing bag



Art. 992840
Sacco Boxe basculante
h. cm. 170 zavorrato con sacchi di sabbia (inclusi)
Self-straightening boxing bag
height cm.170



Art. 992804
Sacco Fit Boxe con pedana riempibile con acqua o sabbia, altezza regolabile (max cm. 220)
Freestanding Fit Boxing bag adjustable height



Art. F350
Kit pera su mensola
Pear for boxing

pg.55



Art. 42233A
Casco Boxe
misure S,M,L,XL
Boxing helmet

pg.55



Art. 44613A
Set protezioni
parastinco +
parapiede
misure S,M,L,XL
Shin/foot protections



Art. 17211
Coppia Fasce Boxe
Boxing bandages



Art. 54613A
Guanti da Sacco in PU
taglie S,M,L,XL
Bag gloves



pg.56

Art. 21796
Guanti Fit Boxe
taglie S,M,L,XL
Fit Boxing gloves



Art. 74613A
Guanti MMA in PU
taglie S,M,L,XL
MMA gloves



Art. 84613A
Guanti Boxe
in pelle
per combattimento
non omologati
8/10/12 oz.
Leather Boxing gloves



Art. GBL10T
Guanti Boxe
Leone in pelle
10 oz.
Leone leather Boxing
gloves

MATERASSI - TAPPETI - Mats



Art. B2001/ ... /B2016

Materassi di caduta realizzati con fodera di rivestimento in PVC antimuffa, antibatterica, ignifuga Cl.2 con imbottitura in gommapiuma di varie densità
(vedere listino per le dimensioni)
Mats of various dimension and thickness

Disponibili anche con fondo antiscivolo preventivo su richiesta
Also available with anti-skid bottom prices on request

pg.48

pg.49

Art. B2033/ ... /B2047

Fodere di ricambio in PVC antimuffa, antibatteriche, ignifughe Cl.2
(vedere listino per le dimensioni)
Spare covers for mats various dimensions



Particolare Art. B2014/ B2015/B2016
(i materassi cm.200x400 sono tagliati a 45° in 2 pezzi tenuti insieme da strisce di velcro)

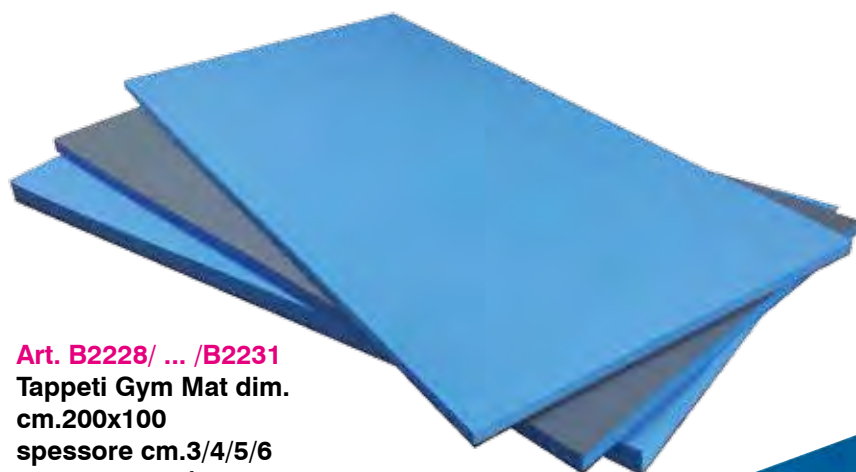

Art. B2228/ ... /B2231

Tappeti Gym Mat dim. cm.200x100 spessore cm.3/4/5/6 ad alta densità in polietilene a cellule chiuse (per uscita attrezzi)
High density Gym Mats

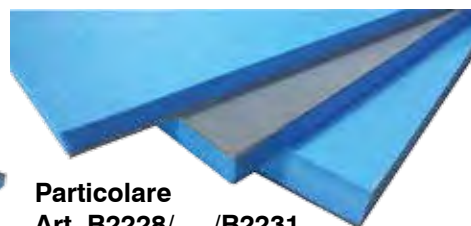

Particolare Art. B2228/ ... /B2231

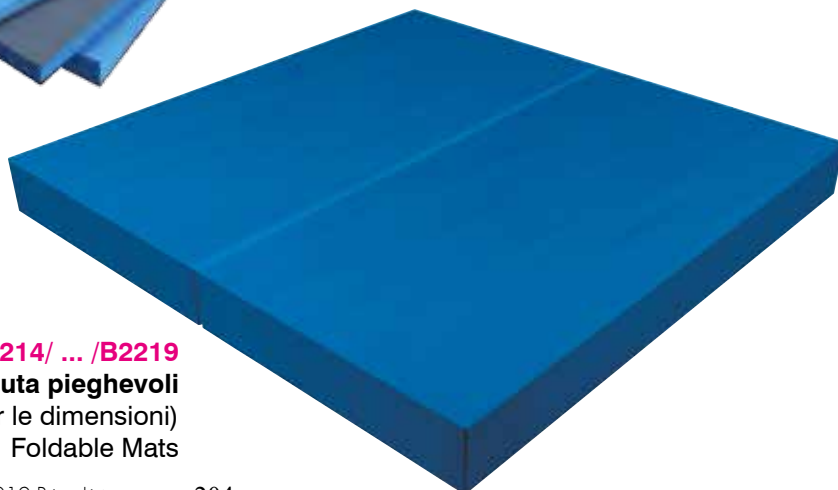

Art. B2214/ ... /B2219

Materassi di caduta pieghevoli
(vedere listino per le dimensioni)
Foldable Mats

Art. S00676
Carrello porta materassi
cm. 200x100
in acciaio verniciato
mobile su ruote
Mat Trolley in painted steel size
200x100 cm. on wheels



● pg.49



Art. S00678
Carrello porta materassi
in verticale cm. 250x105
in acciaio verniciato
mobile su ruote
(elastici inclusi)
Vertical mat Trolley in painted
steel size 250x105 cm.
on wheels
(elastics included)

● pg.50



Art. TEST.M
Tappeto Mat Test cm.100x370
con scala centimetrata da 0 a cm. 300
Mat Test 100x370 cm.

Per allenamento tuffi portieri ed acrobazie giocatori
For GK dive and players' acrobatic shooting training

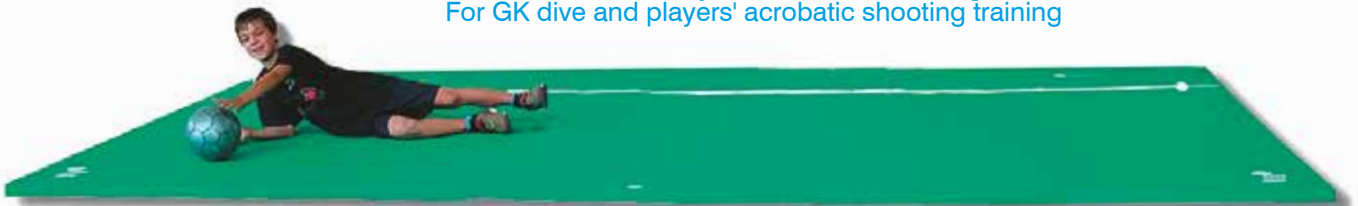

Art. BGAP13
Tappeto Ammortizzante pieghevole dimensioni cm. 200x450
superficie in vinile monospalmato - fondo antiscivolo, imbottitura densità 40 Kg/mc
Foldable soft Mat for goal-keeper and players' safe dives - size 200x450 cm.

● pg.48



PROTEZIONI MURARIE E PER COLONNE - Wall protections



PREVENTIVO SU RICHIESTA
PRICES ON REQUEST

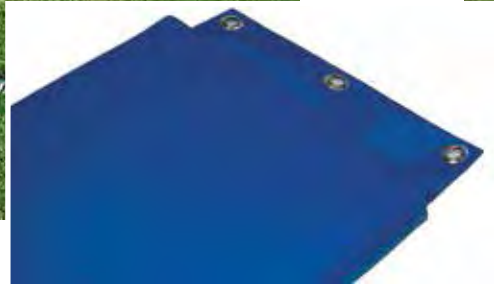

Art. B2085 / B2066

Protezioni murarie e per colonne in vari spessori sagomate su misura in EVA oppure PE alta densità rivestito in PVC fissaggio tramite occhiellature perimetrali, velcro oppure colla - per interno ed esterno
Customized wall and column protections various thickness for indoor and outdoor

pg.48



Art. A10100 / A10150 / A10200
Protezioni paraspigoli in PVC coestruso non ignifugo spessore cm. 1 larghezza cm. 5+5 in vari colori lunghezza cm. 100-150-200
PVC Edge Protections 1 cm. thick width 5+5 cm. length 100-150-200 cm.

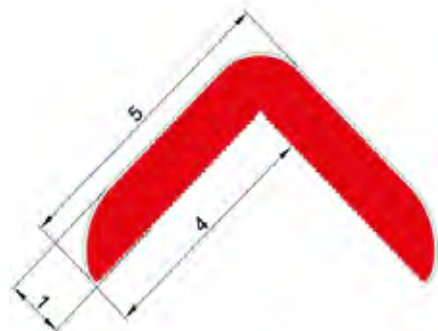

TATAMI

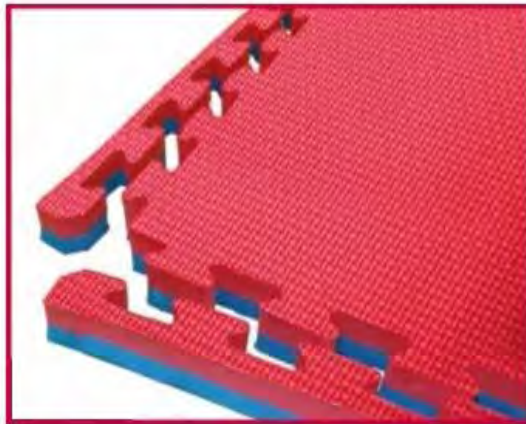

Art. MAT02 / MAT04

**TATAMI ad incastro cm.100x100x2/cm.100x100x4 rosso/blu con 4 bordi
superficie lavabile, antiscivolo, antifunghi, antibatterica, testato anallergico, Certificato EN71
Tatami soft flooring 100x100x2 cm./100x100x4 cm.**

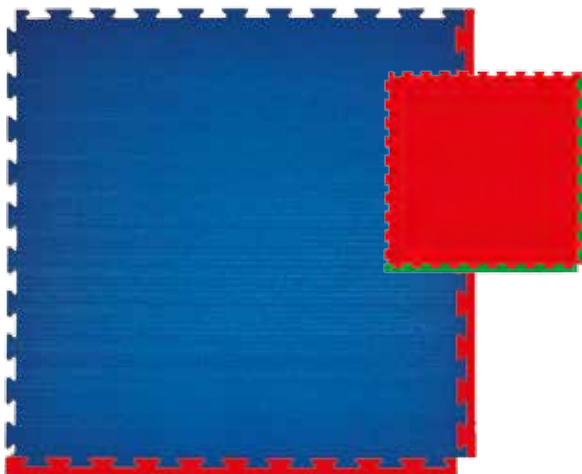

Art. TX-K20

**TATAMI Karate K20
cm. 100x100x2 ad incastro, reversibile
in polietilene espanso reticolato
incluso bordo protettivo perimetrale
colori: verde/rosso, rosso/blu
TATAMI K20 100x100x2 cm.
reversible, perimetric frame included
colors: red/green, red/blue**

pg.56

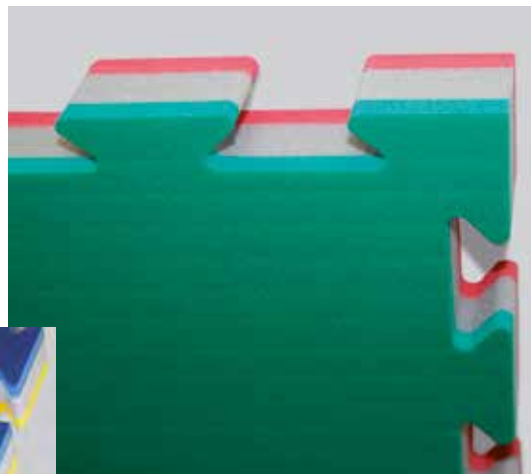

Art. TX-J40

**TATAMI Judo J40
cm. 100x100x4 ad incastro, reversibile
in polietilene espanso reticolato
incluso bordo protettivo perimetrale
colori: verde/bianco/rosso, giallo/bianco/blu
TATAMI J40 100x100x4 cm. 3 colors, reversible,
perimetric frame included
colors: red/green/white, yellow/white/blue**

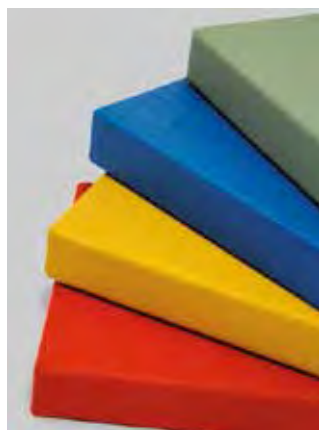

Art. TX-2010

**TATAMI tradizionale
cm. 200x100x4 in PU
densità 230 Kg/mc
rivestito in PVC
con fondo antiscivolo
colori: blu, verde, rosso, giallo
TATAMI 200x100x4 cm.
in PU density 230 Kg/mc
cover with anti-skid PVC stratum
colors: blue, green, red, yellow**

GINNASTICA - Gymnastic



Art. S00352

**Armadio porta attrezzi con vano portavalori
a 4 ripiani in lamiera
dimensioni cm. 100x45x200h
Equipment locker with safe-deposit box**

● pg.50



Art. S00354

**Armadio porta attrezzi a 4 ripiani
in lamiera dimensioni cm. 100x45x200h
Equipment locker**



Art. S00356

**Armadio porta attrezzi
in lamiera dimensioni
cm. 120x45x200h
a 4 ripiani
e porte scorrevoli
Equipment locker with
sliding doors**

● pg.50

● pg.24

Art. V1048
**Armadio in rete con
maniglioni e ruote
telaio in acciaio
dimensioni
cm. 150x75x160h
Equipment locker
on wheels**



Art. S00362
**Mobile porta attrezzi su ruote
Equipment trolley on wheels**



New!



Art. CAGL

Coppia anelli in legno di faggio con cinghie nylon regolabili

Pair of wooden rings with adjustable nylon belts

Art. S0002
Coppia anelli in legno lamellare
Pair of wooden rings



Art. S00018
Confezione da 8 pani magnesio gr. 55
Chalk blocks

pg.50



Art. E8000
Paio scarpette in pelle per ginnastica ritmica
taglie da 26 a 46
Pair of shoes for rhythmic gym
color black or white

Art.S00512

Mensola porta clavette
Club wall holder



Art. P00510/S00502/S00506
Coppia clavette in nylon, in legno a collo lungo e collo corto
Wooden and plastic clubs



Art. CS5
Corda salto per ritmica
m. 3
Jumping rope



Art. P01210
Nastro per ginnastica ritmica m. 6
Rhythmic gym streamer



Art. CS7
Corda salto per ritmica
m. 3 piombata
Weighted jumping rope



Art. S01482
Tamburello completo di batacchio
Rhythmic gym drum



pg.51
Art. S01624
Specchio quadrettato con cornice in legno da fissare a parete
misure cm.200x100
Wall mirror with wooden frame



Art. S01606
Supporto per sbarra regolabile da fissare a parete
Support for bar to be fixed on the wall



Art. S01608
Supporto per sbarra regolabile da fissare a terra
Support for bar to be fixed on the floor

pg.51

Art. S01602
Sbarra per danza in legno (pezzo unico fino a 4 metri)
Wooden bar



Art. 1156TE
Supporto per sbarra regolabile da cm. 78 a cm. 140 in acciaio con base autoportante economica
Cheap freestanding support for bar



Art. S00304
Coppia ceppi Baumann in legno
Pair of Baumann blocks in wood

pg.50



Art. S00302
Coppia appoggi Baumann in legno
Pair of Baumann supports in wood

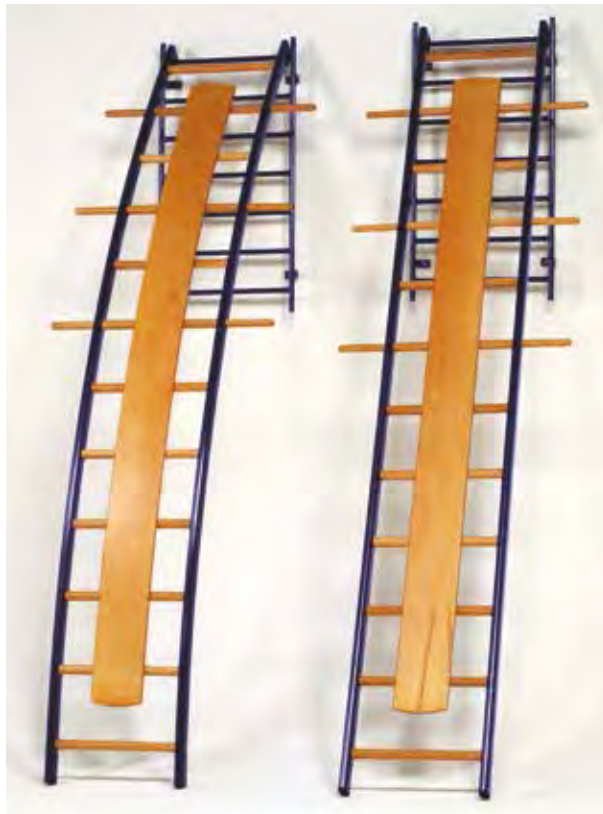

Art. S01052 / S01054 / S01060 / S01062
Scale ortopediche dritte o curve, a parete o trasportabili
Orthopaedic ladders



Art. S00772/S00774
Fune per salita lunghezza m. 5/m. 6
Climbing Rope length 5 m./6 m.

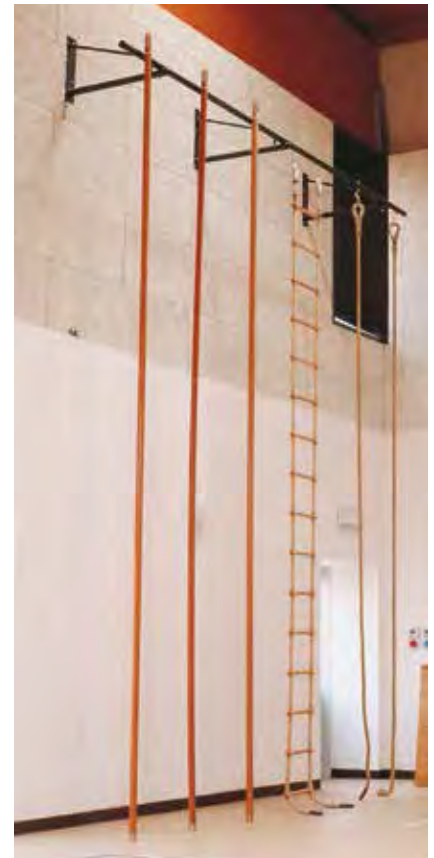

Art. S00754 / S00756
Palchi di salita - Climbing apparatus



Art. S00056 / S00058 / S00052 / S00054
Assi di equilibrio ad altezza fissa e graduabile
Balance beams adjustable and fixed height

pg.50



Art. S00060 / S00064
Trave di equilibrio in alluminio rivestito lungh. mt.5 ad altezza regolabile (a norme F.I.G.) oppure ad altezza fissa
Balance beam 5 meters adjustable height 50-120 cm. or fixed height

pg.51

pg.52



Art. S00204/S00206/S00208/S00210
Pedane elastiche con piano di battuta in legno, ricoperto in gomma, ricoperto in moquette o a doppio molleggio
Springboards



Art. S00104
Cavallo per volteggio senza maniglie rivestito in cuoio sintetico altezza regolabile
Vaulting buck adjustable height

pg.50



Art. V1168
Cavallina regolamentare rivestita in cuoio sintetico altezza regolabile da cm. 90 a cm.130
Vaulting buck adjustable height



pg.51

Art. S00218/S00220
Tappeto arrotolabile per pedana corpo libero in poliuretano e moquette, rotolo da m. 15/25 altezza cm. 100/200
Gymnastic moquette floor, roll m.15/25 long 100/200 cm. height



pg.14

Art. S00914/S00918/S00920
Panche svedesi
Swedish benches



Art. S00252
Sbarra orizzontale
per volteggi regolabile in
altezza, fissaggio
a terra con tiranti
Vaulting bar adjustable height



Art. S00160
Parallela Scolastica a losanga
ad altezza fissa, staggi in legno lamellare
Scholastic parallels fixed height

pg.51



Art. S00156
Parallela Asimmetrica Femminile in acciaio verniciato
su basamento pesante, montanti graduabili,
staggi in legno lamellare regolabili in altezza e larghezza
Asymmetrical bars adjustable height



Art.S00152
Parallela Maschile in acciaio verniciato
su basamento pesante, montanti graduabili,
staggi in legno lamellare
regolabili in altezza e larghezza
Parallels bars adjustable height

ATLETICA - Track & Field



Art. PBS-SI
Blocco di partenza da allenamento in acciaio zincato
Starting Blocks in galvanized steel



Art. BL01
Paio Blocchi di partenza in gomma per palestra
Pair of gym Starting Blocks in rubber for beginners



Art. S02010/PPA38
Testimoni per staffetta in PVC o omologati in alluminio
PVC or aluminium relay baton

pg.52



Art. 500013/PG2
Pettorali per gare atletica
Numbers for competitions



Art. S02112
Megafono a transistor portatile
Handy megaphone



Art. F601
Ostacolo per Atletica in ferro zincato graduabile cm. 50-60-76,2
Adjustable height hurdle in galvanized steel



Art. S02126
Pistola a tamburo per starter
Starter's revolver gun

pg.52



Art. F602
Ostacolo per Atletica in ferro zincato graduabile cm. 76,2-84-91,4
Adjustable height hurdle in galvanized steel

Art. S02072
Ostacolo per Atletica in alluminio anodizzato graduabile cm. 76,2-84-91,4-100-106,7 omologato I.A.A.F.
Adjustable height hurdle in anodized aluminium according to I.A.A.F. standards



Art. S02064
Ostacolo per Atletica in acciaio graduabile cm. 76,2-84-91,4-100-106,7
Adjustable height hurdle in steel



Art. VSH-222
Ostacolo per Atletica Vinex olimpionico in ferro zincato omologato I.A.A.F.
Adjustable height hurdle in galvanized steel according to I.A.A.F. standards



Art. S02552
Coppia ritti salto in alto scolastici altezza cm.200
Scholastic High Jump height 200 cm.



Art. S02554
Coppia ritti salto in alto scolastici in acciaio zincato altezza cm.230
Scholastic High Jump height 230 cm.



Art. S02556
Coppia ritti salto in alto in acciaio zincato periscopici h. cm.250
High Jump height 250 cm.

pg.54



Art. S02558
Coppia ritti salto in alto in acciaio zincato periscopici da competizione h. cm.260
Competition High Jump height 260 cm.



Art. S02584
Piattaforma zincata di sostegno e sollevamento area di caduta
Galvanized steel support platform for landing area

pg.55

Art. B2080/B2081
Zone di caduta salto in alto
High Jump landing mats



Art. S02566
Asta segnalimite in PTE per salto in alto
High Jump crossbar with soft PTE cylinders



Art. PVS-CPTA
Coppia ritti per salto con l'asta in alluminio graduabili fino a cm. 650
Pair of aluminium pole vault stands

Art. B2077/B2078
Zone di caduta salto con l'asta
Pole vault landing mats



Art. S02568 / S02570
Asta segnalimite per salto in alto m. 4 in alluminio o vetroresina
High Jump aluminium or fiberglass crossbar



pg.53

Art. TT09/ ... /VT15
Palle lancio
in gomma Trial,
varie grammature
 Trial rubber throwing balls



Art. VDL5/ ... /VDL72
Palle getto anelastiche
in gomma Trial
per indoor
varie grammature
 Trial shot balls
 in rubber for indoor



Art. S02486/ ... /S02496
Palle getto in metallo verniciato
tarate, varie grammature
 Metal shot balls



Art. S02510
Pedana per lancio del peso
in acciaio zincato
 Galvanized steel shot put throwing circle

pg.54



Art. S02512
Fermapiede getto del peso
in legno massiccio
 Shot put toe board in wood

Art. STB-F100
Fermapiede getto del peso
in vetroresina - I.A.A.F.
 Shot put toe board in fiberglass - I.A.A.F.



pg.52

Art. VVS-100
Podio vincitori in metallo verniciato,
piano in laminato - impilabile
 Painted Iron Podium



Art. CT6
Chiodo per scarpa
in acciaio da mm.6 modello
Albero di Natale
 Shoe steel stud 6 mm.

New!



Art. P9
Chiodo per scarpa in acciaio da
mm.9 modello Pyramid
 Shoe steel stud 9 mm.

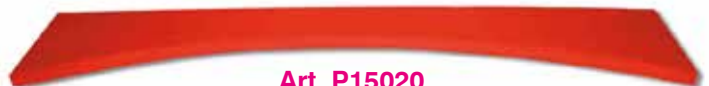

Art. P15020
Pedana Lancio in neoprene espanso
per allenamento lancio disco, giavellotto, peso,
martello e salto in lungo
 Training toe board

pg.54

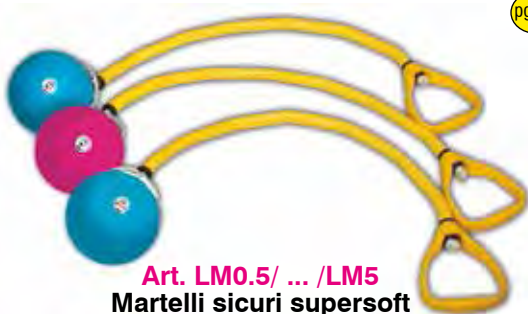

pg.54

Art. LM0.5/ ... /LM5
Martelli sicuri supersoft
in gomma Trial
varie grammature
 Supersoft Trial hammers



Art. PM2/ ... /PM10
Martelli in acciaio da allenamento Polanik
 Polanik steel hammers



Art. DSK1/ ... /DSK2
Dischi in gomma Trial varie grammature
Discus in rubber Trial



Dischi Jet speciali per avviamento al lancio con peso distribuito sulla parte esterna per favorire la penetrazione nell'aria
Special Jet discus with weight distributed mainly on the external perimeter in order to increase air penetration

Art. JET03 / JET05 / JET1
Dischi Jet in gomma Trial
Kg. 0,3/0,5/1
Jet discus in rubber Trial

pg.52

pg.53



Art. DT0.4/ ... /DT1
Dischi Trial a 3 impugnature in gomma approvati I.A.A.F. per attività scolastica
Trial discus approved by I.A.A.F. for school training

Art. W4T/ ... /W10T
Giavellotti Polanik in lega leggera puntale acciaio varie grammature
Polanik Javelins in light alloy with steel edge in various weights



Art. TPD075/ ... /TPD3
Dischi in plastica bordati in acciaio Polanik
Polanik discus in plastic-steel



Art. CPD1/ ... /CPD2
Dischi in nylon bordati in acciaio Polanik - omologati I.A.A.F.
Polanik discus in nylon-steel

pg.53



Art. TRTJ
Turbo Jav per avviamento al lancio
Turbo Jav for throwing introduction



Art. P15262
Junior Jav in polietilene espanso
cm. 88
grammi 50

Art. JAL-C400/ ... / JAL-C800
Giavellotti Vinex in lega leggera puntale in acciaio varie grammature
Vinex Javelins in light alloy with steel edge in various weights



Art. VMH
Vortex per avviamento al lancio del giavellotto e per football americano
Vortex for throwing introduction

pg.53



Art. VMH.J
Mini Vortex gr. 40 lunghezza cm. 17

PILATES



Art. EVA.P
Mattoncino pilates in eva
cm.22,5x14,5x7,5h
 Block for pilates



pg.57

Art. MPS30
Mattoncino pilates gonfiabile
Trial soft gr. 300 cm.12x24x3,5h
 Inflatable block for pilates

Art. MPS50
Mattoncino pilates gonfiabile
Trial soft gr. 500 cm.11,3x24x5,5h
 Inflatable block for pilates



Art. AHF-065/AHF-066
Sfera tonificante
verde kg.1 / viola kg.1,5
 Toning balls

Art. AHF-045
Palla per yoga
ø cm.25
 Yoga ball



Art. BA4
Palla tender per pilates
ø cm.20 - gr. 180
super soffice e sicura
 Trial rubber tender ball
 for pilates



Art. TR38
 Toning ring

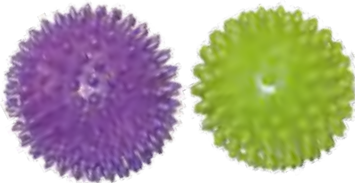

Art. AHF-001
Coppia sfere per massaggi
verde ø cm.7,5
viola ø cm.9
 Massage balls



Art. FY9512
Fitball roller
gonfiabile
diametro cm.18
 Fitball roller inflatable



Art. AHF-020
 Power grip ball

pg.22

Art. B55 / B75
Relax Ball Trial
ø cm.5,5 / 7,5
 Relax Ball

Art. 995025
Cilindro pieno
Foam roll
lunghezza cm. 90
ø cm.15
 Foam roll not
 inflatable



Art. 995025BIS
Mezzo cilindro
pieno Foam roll
lunghezza cm. 90
altezza cm.7,5
 Half Foam roll
 not inflatable



Art. AHF-044
Rullo massaggio
lunghezza cm.33
ø cm.14
 Massaging roll



Art. AHF-111
Rullo massaggio
con impugnature
cm.53 ø cm.4,5
 Massaging roll



pg.24



Art. TBSA/TBSB
Palla Boa autobilanciante in gomma Trial
oscilla ma torna al suo posto senza rotolare,
stabile, ideale per correggere la postura,
monocolore per adulti/bicolore per bambini
 Trial rubber Boa Ball swings but comes back
 to its original position - very good for postural
 therapy for adults and children

PALLAPUGNO - BOCCE - TAMBURELLI



Art. BA1
Air Ball Trial Ø cm. 12 gr. 100
morbida e rimbalzante
(ideale anche per pallapugno)
Trial Air Ball



Art. M05010
Pallapugno FIPAP
diametro cm. 14
FIPAP pallapugno



Art. M506
Guanto da gioco per pallapugno
Pallapugno glove



Art. ST14
Palla Canguro Ø cm. 45
Trial Cangaroo Ball

 pg.57



Art. ST15
Palla Canguro Ø cm. 55
Trial Cangaroo Ball



Art. ST16
Palla Canguro Ø cm. 65
Trial Cangaroo Ball



Art. ASKB
Set 8 bocce in legno laccato
diametro mm. 100
con pallino diametro mm. 40
Set 8 wooden bowls

Art. BTST12
Set 6+6 bocce supersoft
con pallino e borsa
Set of 12 supersoft
bowls with bag



Art. P18110
Tamburello indoor
diametro cm. 26
(fino a 13 anni)
omologato FIPT
FIPT indoor
tamburello Ø cm. 26



Art. P18111
Tamburello indoor
diametro cm. 28
omologato FIPT
FIPT indoor tamburello
Ø cm. 28



Art. S00552 / S00556
Funne per tiro alla fune
lunghezza m. 15 / m. 25
con indicazioni colorate
Rope for tug of war
length 15 / 25 meters



Art. P18112
Pallina per tamburello
depressurizzata
indoor diametro cm. 6,5
grammi 40
Tamburello indoor depressurized ball



Art. I-059

Set 10 mattoncini dritti
cm. 25x16x13h
 Set of 10 straight bricks

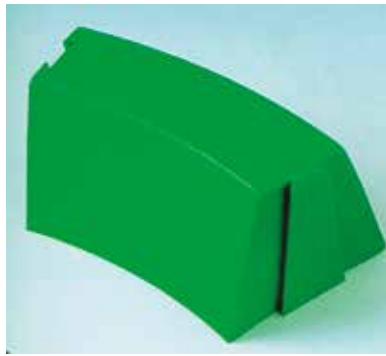

Art. I-060

Set 10 mattoncini curvi
cm. 22x16x13h
 Set of 10 curved bricks

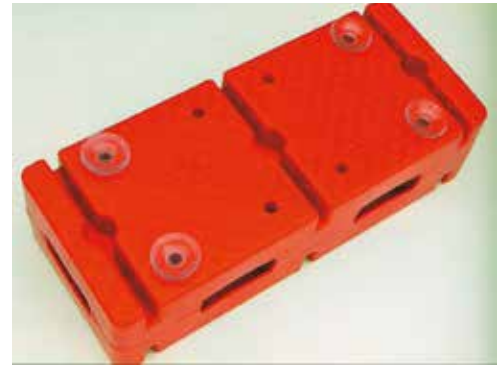

Art. I-098

Blocco percorso
cm. 30x15x10h
 Block for route



Art. PCAD

Paracadute Ø cm. 300
 Parachute

 pg.57



Art. I-061

Percorso equilibrio composto da
5 assi + 6 mattoncini + 24 ventose
 Balance route



Art. S00794

 pg.51

Pannello per arrampicata in legno
agganciabile a spalliera o quadro
svedese
 Climbing board



PALLA
AVVELENATA
Dodgeball



Art. TDB16

Palla per Dodgeball diametro cm. 16
peso grammi 210 colore arancio fluo
 Dodgeball Ø cm. 16

Art. TDB20

Palla per Dodgeball diametro cm. 20
peso grammi 230 colore giallo fluo
 Dodgeball Ø cm. 20



SKATEBOARD - PATTINI - MONOPATTINI - FRISBEE



Art. SKM2401 Skateboard Junior cm.61



Art. SKM3103 Skateboard Senior cm.77,5

New!



Art. F4-400
Casco Skate
taglie S, M, L
Skate helmet

pg.56

Art. 681171
Set 3 protezioni Junior

Art. 132171
Set 3 protezioni Senior
(misura S, M, L)
Junior and Senior protections



pg.45

Art. GB100.03
Set 2 palette
Front and Back con 2 palline
Front and Back set



Art. F4JR026
Pattino in line
allungabile Junior
Taglie: 30/33 - 34/37 - 38/41
In line skate adjustable size



Art. ML32B
Monopattino
pieghevole,
ruote da 125 mm.
peso massimo
utilizzatore 50 kg.
Junior Scooter



Art. ML001
Monopattino
pieghevole,
ruote da 200 mm.
peso massimo
utilizzatore 100 kg.
Scooter



Art. FRPPR
Frisbee
diametro cm. 27,5 - gr.160
Frisbee



BARRET®

ATTREZZATURE PER L'ALLENAMENTO DEI CAMPIONI
TRAINING TOOLS FOR CHAMPIONS



TECHNICAL SUPPLIER

BARRET s.r.l.

Via Marie Curie, 6/8
Zona Ind.le S. Pietro in Palazzi
57023 Cecina (LI) - Italy
telefono (+39) 0586 661215
fax (+39) 0586 662417
info@barretsport.com
www.barretsport.com

